

## Errata

**Title & Document Type:** 5300B/10A Measuring System Operating and Service Manual

**Manual Part Number:** 05300-90035

**Revision Date:** May 1977

---

### HP References in this Manual

This manual may contain references to HP or Hewlett-Packard. Please note that Hewlett-Packard's former test and measurement, semiconductor products and chemical analysis businesses are now part of Agilent Technologies. We have made no changes to this manual copy. The HP XXXX referred to in this document is now the Agilent XXXX. For example, model number HP8648A is now model number Agilent 8648A.

### About this Manual

We've added this manual to the Agilent website in an effort to help you support your product. This manual provides the best information we could find. It may be incomplete or contain dated information, and the scan quality may not be ideal. If we find a better copy in the future, we will add it to the Agilent website.

### Support for Your Product

Agilent no longer sells or supports this product. You will find any other available product information on the Agilent Test & Measurement website:

[www.tm.agilent.com](http://www.tm.agilent.com)

Search for the model number of this product, and the resulting product page will guide you to any available information. Our service centers may be able to perform calibration if no repair parts are needed, but no other support from Agilent is available.

# MEASURING SYSTEM 5300B AND BATTERY PACK 5310A

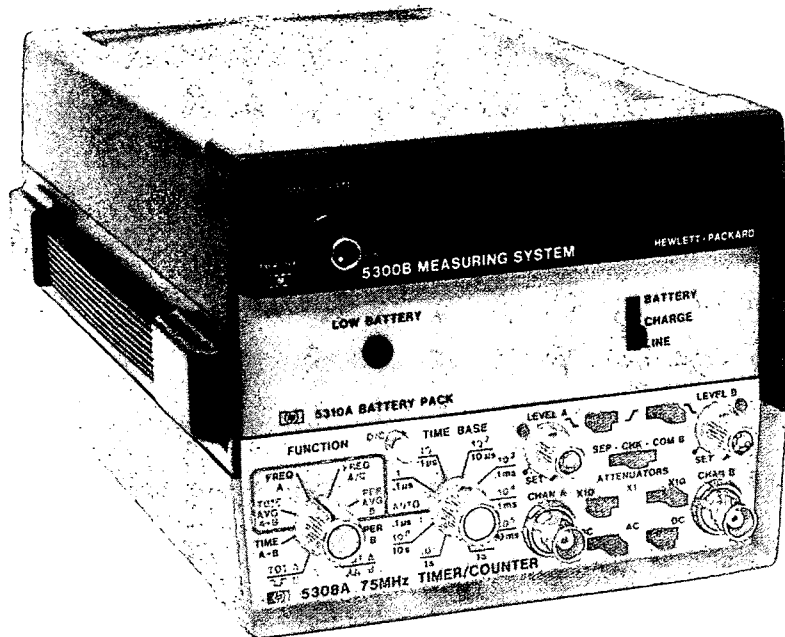

OPERATING AND SERVICE MANUAL

## MEASURING SYSTEM

5300B

AND

BATTERY PACK

5310A

5300B SERIAL PREFIX 1704A  
5310A SERIAL PREFIX 1312A

This manual applies directly to HP Model 5300B Measuring System Mainframes having serial prefix 1704A and to HP Model 5310A Battery Packs having serial prefix number 1312A.

### SERIAL PREFIXES NOT LISTED

For serial prefixes above those given above, a "Manual Changes" sheet should be included with this manual. If the change sheet is missing request one from the nearest Hewlett-Packard Sales and Service Office. Offices are listed at the end of this manual. For instrument with serial prefixes below those listed above see Section VII.

Copyright      HEWLETT-PACKARD COMPANY      1973  
5301 STEVENS CREEK BLVD., SANTA CLARA, CALIF. 95050

Printed: MAY 1977

*Manual Change Page  
Revision No. 3  
Revised: May 1, 1977*  
PRINTED IN U.S.A.

MANUAL PART NO. 05300-90035  
MICROFICHE PART NO. 05300-90036

HEWLETT  PACKARD

TABLE OF CONTENTS

Section		Page
I	GENERAL INFORMATION .....	1-1
	1-1. Introduction .....	1-1
	1-3. Description .....	1-1
	1-5. Purpose and Use of Manual .....	1-1
	1-8. Applications .....	1-1
	1-10. Instrument Identification .....	1-2
	1-14. Manual Changes and Options .....	1-2
	1-16. Equipment Supplied and Accessories Available .....	1-2
	1-18. Manual Microfiche .....	1-2
II	INSTALLATION .....	2-1
	2-1. Introduction .....	2-1
	2-3. Unpacking and Inspection .....	2-1
	2-5. Storage and Shipment .....	2-1
	2-8. Power Connection .....	2-1
	2-13. Installation and Removal of Plug-On Modules .....	2-3
	2-15. Portable Operation .....	2-3
	2-18. Maintenance .....	2-5
	2-20. Alternate Power Cables .....	2-5
III	OPERATION .....	3-1
	3-1. Introduction .....	3-1
	3-3. Accuracy .....	3-1
	3-5. Front Panel .....	3-1
	3-7. Rear Panel .....	3-2
	3-10. 5300B Operating Procedures .....	3-2
	3-12. 5310A Operating Procedures .....	3-2
IV	THEORY OF OPERATION .....	4-1
	4-1. Introduction .....	4-1
	4-3. Overall Circuit Operation .....	4-1
	4-10. Detailed Circuit Operation .....	4-1
	4-12. Eight-Digit Display .....	4-3
	4-18. Counter .....	4-3
	4-23. Data Control ROM .....	4-4
	4-27. Time Base .....	4-4
	4-29. A1U9 Control .....	4-9
	4-36. Time Base Reference Oscillator .....	4-10
	4-38. Power Supply .....	4-10
	4-50. A1J1 Connector .....	4-12
	4-52. 5310A Battery Pack .....	4-12
V	MAINTENANCE .....	5-1
	5-1. Introduction .....	5-1
	5-3. Recommended Test Equipment .....	5-1
	5-5. Instrument Access .....	5-1
	5-7. Periodic Maintenance .....	5-2
	5-9. Maintenance and Repair .....	5-2
	5-13. Instrument Troubleshooting .....	5-2
	5-23. Diagnostic Test Card "A" .....	5-4
	5-28. Diagnostic Test Card "B" .....	5-4
	5-35. Diagnostic Test Card "C" .....	5-4
	5-42. Diagnostic Test Card "D" .....	5-8
	5-48. Alternate Method of Trouble Isolation .....	5-10
	5-51. Oscillator Adjustment .....	5-10
	5-53. Standard Oscillator Direct Count Measurement and Adjustment .....	5-10

**TABLE OF CONTENTS (Continued)**

Section		Page
V	<b>MAINTENANCE (Continued)</b>	
	5-56. Standby Oscillator Measured by Oscilloscope-Drift Method .....	5-14
	5-58. Option 001 High Stability Time Base (TCXO) Measurement and Adjustment .....	5-14
	5-60. HP 5310A Battery Pack .....	5-17
	5-61. Battery Capacity Check .....	5-17
	5-63. Replacing Internal Battery Supply .....	5-18
	5-65. Removing A2 Power Supply Board .....	5-18
VI	<b>REPLACEABLE PARTS</b> .....	6-1
	6-1. Introduction .....	6-1
	6-4. Ordering Information .....	6-1
VII	<b>MANUAL CHANGES AND OPTIONS</b> .....	7-1
	7-1. Introduction .....	7-1
	7-3. 5300A Measuring System .....	7-1
	7-5. Options .....	7-1
	7-7. Field Installation of Option 001 .....	7-1
	7-9. Manual Changes .....	7-1
	7-11. Newer Instruments .....	7-1
	7-13. Older Instruments (5310A Battery Packs) .....	7-1
	7-17. Older Instruments (5300B) .....	7-1
VIII	<b>SCHEMATIC DIAGRAMS</b> .....	8-1
	8-1. Introduction .....	8-1
	8-3. Schematic Diagram Notes, Assembly Numbers, and Reference Designators .....	8-1
	8-5. Reference Designations .....	8-1
	8-7. Identification Markings on Printed-Circuit Boards .....	8-1

**LIST OF TABLES**

Table		Page
1-1.	Equipment Supplied .....	1-2
1-2.	Accessories Available .....	1-2
1-3.	Specifications when used with Available Plug-Ons .....	1-4
1-4.	Accessory Battery Pack Specifications .....	1-5
2-1.	115/230 Volt Conversion .....	2-1
4-1.	A1U5 Data Control ROM Listing .....	4-5
4-2.	ROM Sequence for 5310A, 5302A, 5304A (Frequency Measurements, and 5307A Plug-Ons .....	4-6
4-3.	ROM Sequence for 5303B, 5305A, and 5308A Plug-Ons .....	4-6
4-4.	ROM Sequence for 5306A Plug-On (Volt and Ohm Measurements) .....	4-7
4-5.	A1J1 Signals .....	4-13
5-1.	Recommended Test Equipment .....	5-1
5-2.	Tests 1, 2, 3, and 4 .....	5-11
5-3.	Tests 6, 7, and 8 .....	5-12
5-4.	Tests 9, 10, 11, 12, 13, 14, 15, and 16 .....	5-13
6-1.	Replaceable Parts .....	6-3
6-2.	Replaceable Parts for 5310A .....	6-9
6-3.	Code List of Manufacturers .....	6-10
7-1.	5300B Backdating .....	7-1
7-2.	5300B Replaceable Parts (A1 Series 1420A or 1428A) .....	7-3

LIST OF FIGURES

Figure		Page
1-1.	Model 5300B Measuring System Mainframe and 5310A Battery Pack .....	1-0
1-2.	Available Plug-Ons .....	1-3
2-1.	Plug-On Installation .....	2-2
2-2.	Preparing for Portable Operation .....	2-4
2-3.	Power Cables .....	2-6
3-1.	Front Panel Controls and Indicators .....	3-1
3-2.	Rear Panel Connectors .....	3-2
4-1.	Simplified Block Diagram .....	4-2
4-2.	A1U1 6-Decade Counter Block Diagram .....	4-4
4-3.	A1U2 Time Base Block Diagram .....	4-8
4-4.	A1U9 Control Block Diagram .....	4-9
4-5.	Power Supply Block Diagram .....	4-11
4-6.	Power Supply Waveforms .....	4-11
5-1.	5300B Power Supply Check .....	5-3
5-2.	Display Checks .....	5-5
5-3.	Display Checks .....	5-7
5-4.	Display Checks .....	5-8
5-5.	A1U1 Counter, A1U2 Time Base, and A1U9 Control Checks .....	5-10
5-6.	A1U1 Counter, A1U2 Time Base, and A1U9 Control Checks .....	5-14
5-7.	Battery Removal .....	5-17
6-1.	5300B Mainframe Mechanical Parts .....	6-11
6-2.	5310A Battery Pack Mechanical Parts .....	6-12
7-1.	5300B Parts Locations with Option 001 Time Base (Series 1420A and 1428A) .....	7-5
7-2.	5300B Parts Locations on A1 with Standard Time Base (Series 1420A or 1426A) .....	7-6
7-3.	5300B Schematic Diagram (A1 Series 1420A and 1428A) .....	7-7
8-1.	Schematic Diagram Notes .....	8-2
8-2.	5310A Battery Pack Parts Locations .....	8-3
8-3.	5310A Battery Pack Schematic Diagram .....	8-3
8-4.	5300B Parts Locations with Option 001 Time Base .....	8-5
8-5.	5300B Waveform Photographs .....	8-6
8-6.	5300B Parts Locations with Standard Time Base .....	8-8
8-7.	Control and Display Signals Timing Diagram .....	8-9
8-8.	5300B Schematic Diagram .....	8-9

# SAFETY CONSIDERATIONS

## GENERAL

This is a Safety Class I instrument. This instrument has been designed and tested according to IEC Publication 348, "Safety Requirements for Electronic Measuring Apparatus", and has been supplied in safe condition.

This operating and service manual contains information, cautions, and warnings which must be followed by the user to ensure safe operation and to retain the instrument in safe condition.

## WARNINGS

### SAFETY

If this instrument is to be energized via an autotransformer for voltage reduction, make sure the common terminal is connected to the earthed pole of the power source.

**BEFORE SWITCHING ON THIS INSTRUMENT**, the protective earth terminals of this instrument must be connected to the protective conductor of the (mains) power cord. The mains plug shall only be inserted in a socket outlet provided with a protective earth contact. The protective action must not be negated by the use of an extension cord (power cable) without a protective conductor (grounding).

Make sure that only fuses with the required rated current and of the specified type (normal blow, time delay, etc.) are used for replacement. The use of repaired fuses and the short-circuiting of fuse holders must be avoided.

Whenever it is likely that the protection offered by fuses has been impaired, the instrument must be made inoperative and be secured against any unintended operation.

## GROUNDING

Any interruption of the protective (grounding) conductor (inside or outside the instrument) or disconnecting the protective earth terminal is likely to make this instrument dangerous. Intentional interruption is prohibited.

## HIGH VOLTAGE

Any adjustment, maintenance, and repair of the opened instrument under voltage should be avoided as much as possible and, when inevitable, should be carried out only by a skilled, qualified person who is aware of the hazard involved.

Capacitors inside the instrument may still be charged even if the instrument has been disconnected from its source of supply.

Adjustments and service described herein are performed with power supplied to the instrument while protective covers are removed. Energy available at many points may, if contacted, result in personal injury.

## CAUTIONS

### LINE VOLTAGE SELECTION

**BEFORE SWITCHING ON THIS INSTRUMENT**, make sure the instrument is set to the voltage of the power source. Verify that the power transformer primary is matched to the available line voltage. Verify that the correct fuse is installed. (See Section II).

## GROUNDING

**BEFORE SWITCHING ON THIS INSTRUMENT**, ensure that all devices connected to this instrument are connected to the protective (earth) ground.

**BEFORE SWITCHING ON THIS INSTRUMENT**, ensure that the line power (mains) plug is connected to a three-conductor line power outlet that has a protective (earth) ground. (Grounding one conductor of a two-conductor outlet is not sufficient.)



This symbol: , which appears on the 5300B instrument means: Read the instruction manual before operating the instrument. The first three sections of the manual are particularly important. If the instrument is operated without reading the instructions, it may not operate correctly.

5300B MEASURING SYSTEM

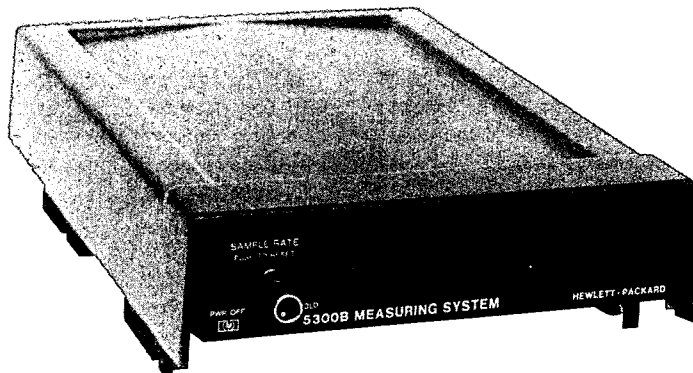

5310A BATTERY PACK

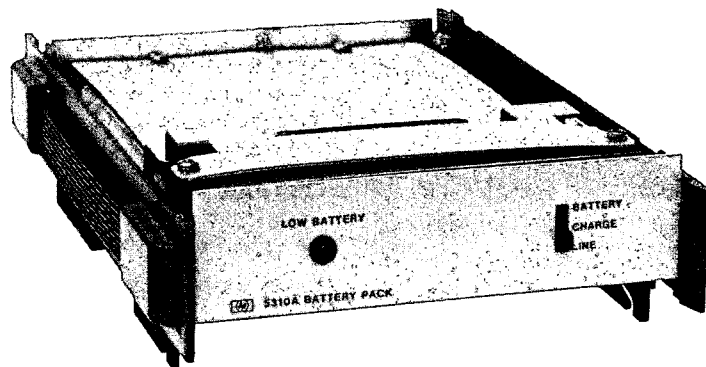

POWER CORD

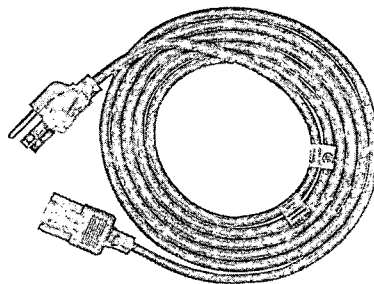

Figure 1-1. Model 5300B Measuring System Mainframe and 5310A Battery Pack



## SECTION I

### GENERAL INFORMATION

#### 1-1. INTRODUCTION

1-2. This manual describes the Hewlett-Packard Model 5300B Measuring System Mainframe and 5310A Battery Pack. Section I is General Information. Section II is Installation. Section III is Operation. Section IV is Theory of Operation. Section V is Maintenance. Section VI is Replaceable Parts. Section VII is Manual Changes and Options. Section VIII is Schematic Diagrams.

#### 1-3. Description

1-4. The Hewlett-Packard Model 5300B Measuring System Mainframe is a rugged, compact, all solid state measuring instrument that is used with a variety of plug-on modules to measure a wide range of parameters. The system has an eight-digit light-emitting-diode (LED) display assembly. The plug-on feature enables the user to select plug-ons which will provide him with a maximum measurement capability for a particular need. The electrical and mechanical specifications for the 5300B Measuring System and 5310A Battery Pack are listed in Tables 1-3 and 1-4, respectively. Several plug-ons are available for the Measuring System, some of these are shown in Figure 1-2.

a. HP Model 5301A 10 MHz Counter. When combined with the 5300B, frequency measurements to 10 MHz can be made.

b. HP Model 5302A 50 MHz Universal Counter. When combined with the 5300B, Frequency, Period, Period Average, Time Interval, Ratio, and Totalizing measurements can be made.

c. HP Model 5303B 525 MHz Counter. When combined with the 5300B, frequency measurements to 525 MHz can be made.

d. HP Model 5304A Timer/Counter. When combined with the 5300B, frequency measurements to 10 MHz and time interval measurements to 500 nsec can be made.

e. HP Model 5305A 1100 MHz Counter. When combined with the 5300B, frequency measurements to 1100 MHz can be made.

f. HP Model 5306A Multimeter/Counter. When combined with the 5300B, ac and dc voltages, resistance, and frequency to 10 MHz can be measured.

g. HP Model 5307A High Resolution Counter. When combined with the 5300B, frequencies from 5

Hz to 2 MHz (or pulses from 50 counts per minute to 10,000,000 counts per minute) can be measured and displayed with six digits of resolution.

h. HP Model 5308A Universal Timer-Counter. When combined with the 5300B, frequency measurements to 75 MHz can be made in the A and B input channel. Period can be measured in Channel B. Period Average can be measured in Channel B. Time Interval can be measured with one or two inputs (A/B or B). Time Interval Average can be measured with one or two inputs. Events can be totalized.

i. HP Model 5310A Battery Pack (available accessory). When installed between the 5300B and a plug-on, a completely portable instrument is available with 3 to 8 hours of operating time.

j. HP Model 5311B Digital-Analog Converter. When installed between the 5300B and a measurement plug-on, any three, or the least significant two, display digits can be converted to an analog signal.

k. Model 5312A HP-IB Interface. When installed between the 5300B and a compatible plug-on, it provides an interface to the Hewlett-Packard Interface Bus. Compatible plug-ons include the 5301A, 5302A, 5303B, 5304A, 5305A, 5306A, 5307A, and 5308A.

#### 1-5. Purpose and Use of Manual

1-6. This manual provides operating and service instructions for the 5300B Measuring System. When the information package which is included with the associated plug-on is inserted into Section IX, the manual becomes an operating and service manual for the 5300B Measuring System and its respective plug-ons. The 5300B Mainframe and the 5310A Battery Pack are covered completely in this manual.

1-7. The manual is intended to familiarize the user with his unit. Included are operation, theory, maintenance information, schematic diagrams, component locators, and parts lists.

#### 1-8. APPLICATIONS

1-9. The 5300B Measuring System can be used in airborne and ground radio communications and radar servicing, industrial electronics servicing, and various other electronics-related fields. The Battery Pack

(HP 5310A) enables the Measuring System to be used in field-service situations where ac power is not available or in applications which require isolation from power lines.

### 1-10. INSTRUMENT IDENTIFICATION

1-11. Hewlett-Packard uses a two-section nine-digit serial number (0000A00000), on the back panel, to identify the instrument.

1-12. The first four digits specify the serial prefix and the last five digits refer to the specific instrument. If the serial prefix on your instrument differs from that listed on the title page of the manual, there are differences between the manual and your instrument.

1-13. Lower serial prefixes are documented in Section VII and higher serial prefixes are covered by a manual change sheet included with the manual.

### 1-14. MANUAL CHANGES AND OPTIONS

1-15. The title page lists the serial prefix number to which this manual directly applies. If the serial prefix number is different from the one listed, a manual

change sheet is included, describing the required changes. If the change sheet is missing, the information can be supplied by a Hewlett-Packard Sales and Service Office listed in Section VIII of this manual. Options are listed in Section VII of this manual.

### 1-16. EQUIPMENT SUPPLIED AND ACCESSORIES AVAILABLE

1-17. Table 1-1 lists equipment supplied with the 5300B and Table 1-2 lists accessories available.

Table 1-1. Equipment Supplied

DESCRIPTION	HP PART NO.
Detachable Power Cord (I.E.C. type approved)	8120-1378

### 1-18. MANUAL MICROFICHE

1-19. On the title page of this manual, below the manual part number, is a "Microfiche" part number. This number may be used to order 4x6-inch microfilm transparencies of the manual. The microfiche package also includes the latest Manual Changes supplement as well as all pertinent Service Notes.

Table 1-2. Accessories Available

DESCRIPTION	HP PART NO.
Service Support Package (see Section V for items and description) .....	10547A
Diagnostic Cards (see Section V for items and description) .....	10548A
Battery Pack: 12 Vdc, 4-8 hours operating time .....	5310A
Digital-to-Analog Converter .....	5311A
HP-IB Interface .....	5312A
Rack Mount Kits:	
For 5300 and one plug-on .....	10851A
For Two 5300's with two plug-ons .....	10852A
For 5300, plug-on, and plug-between .....	10853A
For Two 5300's, two plug-ons, and two plug-betweens .....	10854A

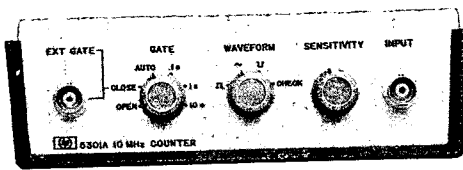

5301A

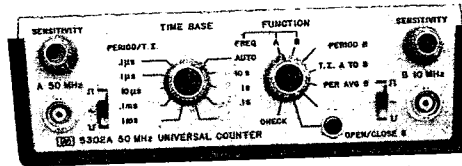

5302A

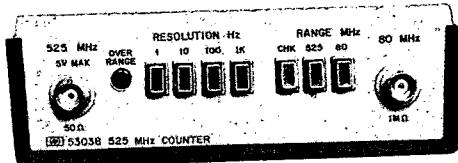

5303B

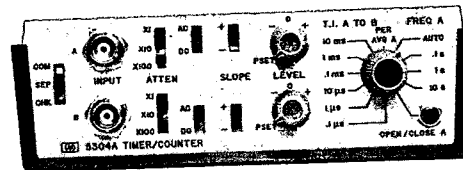

5304A

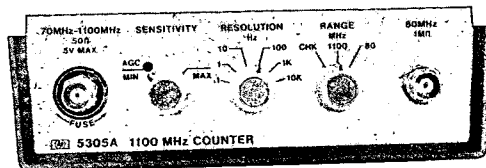

5305A

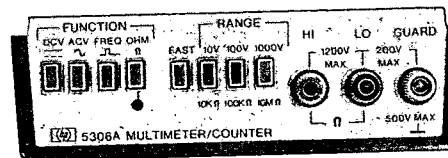

5306A

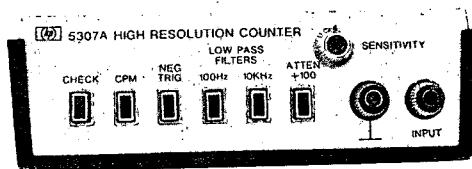

5307A

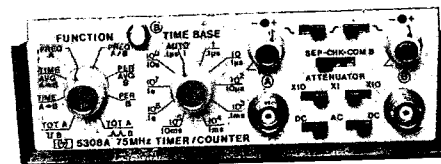

5308A

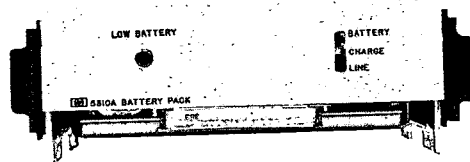

5310A

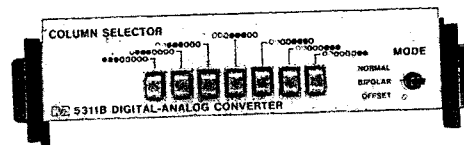

5311B

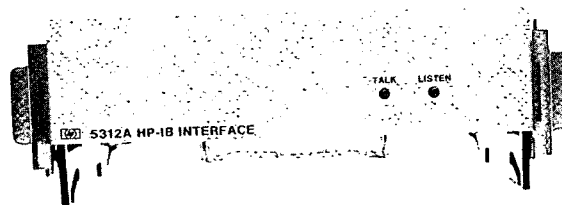

5312A

Figure 1-2. Available Plug-Ons

Table 1-3. Specifications when used with Available Plug-Ons

TIME BASE	GENERAL (Continued)																				
<p><b>FREQUENCY:</b> 10 MHz.</p> <p><b>STABILITY:</b>  <b>Aging Rate:</b> &lt;3 parts in 10<sup>7</sup>/mo.  <b>Temperature:</b> &lt;±5 parts in 10<sup>6</sup>, 0°C to 50°C.                      Typically: &lt;±2 parts in 10<sup>6</sup>, 15°C to 40°C.  <b>Line Voltage:</b> &lt;±1 part in 10<sup>7</sup> for 10% line variation.</p> <p><b>OSCILLATOR OUTPUT:</b> 10 MHz, approximately 1V rms at rear BNC, 100Ω source impedance.</p> <p><b>EXTERNAL INPUT:</b> 1 MHz to 10 MHz, 1V rms into 500Ω.</p> <p style="text-align: center;"><b>NOTE</b></p> <p>The external input must be 10 MHz for a correct display. For example, with 1 MHz input the display will be 10 times greater than with 10 MHz input.</p> <p style="text-align: center;"><b>OPTION 001: HIGH STABILITY TIME BASE</b></p> <p><b>FREQUENCY:</b> 10 MHz.</p> <p><b>STABILITY:</b>  <b>Aging Rate:</b> &lt;2 parts in 10<sup>7</sup>/mo initially, &lt;1 part in 10<sup>7</sup>/mo after 2 months.  <b>Temperature:</b> &lt;±5 parts in 10<sup>7</sup>, 0 to 50°C.  <b>Line Voltage:</b> &lt;±5 parts in 10<sup>8</sup> for 10% line variation.</p> <p><b>OSCILLATOR OUTPUT:</b> 10 MHz, approximately 1V rms at rear panel BNC, 200Ω source impedance.</p> <p><b>EXTERNAL INPUT:</b> 1 to 10 MHz, 1V rms into 500Ω.</p>	<p><b>HOLD POSITION:</b> Display can be held indefinitely.</p> <p><b>PUSH TO RESET:</b> Front panel pushbutton switch resets all registers and initiates a new measurement. Pressing this switch also test lights all the display LED seven segments, five decimal points and the overflow indicator. The LED digits show .</p> <p><b>OPERATING TEMPERATURE:</b> 0°C to 50°C.</p> <p><b>POWER REQUIREMENTS:</b> 115 to 230V +13 to -17%, 48 to 440 Hz, 25 Va maximum (depends on plug-on module). Mainframe power without plug-on nominally 5 watts. Battery operation: with 5310A rechargeable battery pack see 5310A specifications).</p> <p><b>WEIGHT:</b> Net 1.5 kg (3-1/3 lb), shipping 2.5 kg (5-1/2 lb).</p> <p><b>DIMENSIONS (with snap-on module):</b> Height, 89 mm (3-1/2"), Width, 160 mm (6-1/4"), Depth, 248 mm (9-1/4").</p> <div style="text-align: center;">  </div> <p><b>MAINFRAME/PLUG-ON COMPATIBILITY:</b></p> <table border="1" style="width: 100%; border-collapse: collapse;"> <thead> <tr> <th style="text-align: center;">Plug-On</th> <th style="text-align: center;">Display Digits</th> </tr> </thead> <tbody> <tr> <td>5301A .....</td> <td style="text-align: center;">7</td> </tr> <tr> <td>5302A .....</td> <td style="text-align: center;">7</td> </tr> <tr> <td>5303B .....</td> <td style="text-align: center;">8</td> </tr> <tr> <td>5304A .....</td> <td style="text-align: center;">7</td> </tr> <tr> <td>5305A .....</td> <td style="text-align: center;">8</td> </tr> <tr> <td>5306A (Frequency) .....</td> <td style="text-align: center;">7</td> </tr> <tr> <td>                  (ACV, DCV, OHMS) .....</td> <td style="text-align: center;">5</td> </tr> <tr> <td>5307A .....</td> <td style="text-align: center;">6</td> </tr> <tr> <td>5308A .....</td> <td style="text-align: center;">8</td> </tr> </tbody> </table>	Plug-On	Display Digits	5301A .....	7	5302A .....	7	5303B .....	8	5304A .....	7	5305A .....	8	5306A (Frequency) .....	7	(ACV, DCV, OHMS) .....	5	5307A .....	6	5308A .....	8
Plug-On	Display Digits																				
5301A .....	7																				
5302A .....	7																				
5303B .....	8																				
5304A .....	7																				
5305A .....	8																				
5306A (Frequency) .....	7																				
(ACV, DCV, OHMS) .....	5																				
5307A .....	6																				
5308A .....	8																				
<b>GENERAL</b>																					
<p><b>DISPLAY:</b> 8-Digit, 7-Segment Matrix. Solid state LED display (Gallium Arsenide Phosphide Light Emitting Diodes) including decimal point and annunciator units.</p> <p><b>OVERFLOW:</b> LED light indicates when display range is exceeded.</p> <p><b>DISPLAY STORAGE:</b> Holds reading between samples</p> <p><b>SAMPLE RATE:</b> Sample rate control adjusts the delay from the end of the one measurement to the start of a new measurement. Continuously variable from less than 50 msec to greater than 5 seconds.</p>																					

Table 1-4. Accessory Battery Pack Specifications

**5310A BATTERY PACK**

Provides battery power to 5300 mainframe and plug-on modules from rechargeable Nickel-Cadmium cells.

Battery Voltage: 12 Vdc.

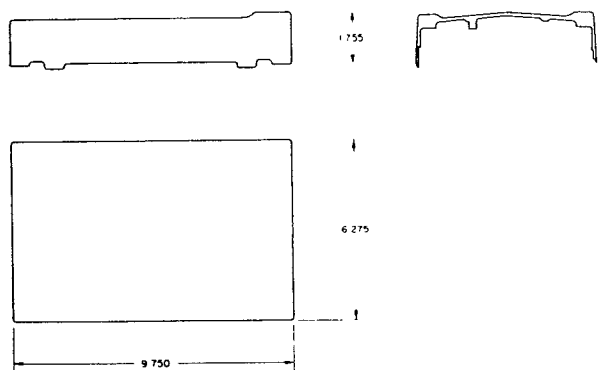
Battery Capacity: Nominal 48-watt hours.

Operating Time: Minimum of 3 hours operation (typically 5 hours) at 20°C to 30°C (operating and charging temperatures, depending on plug-on used).

Recharging Power: Provided by 5300 mainframe. 18 hours recharge time from minimum level (indicated by LOW BATTERY indicator) to full charge.

**CAUTION**

**MAXIMUM RECHARGE TIME IS 24 HOURS. MORE THAN 24 HOURS OF CHARGING MAY DAMAGE BATTERIES (REFER TO SECTION V).**

Low Voltage Indicator: Solid state warning light begins to glow when battery voltage drops below minimum level (approximately 10% remaining charge).

Line Failure Protection: Allows instrument to be operated in LINE position with automatic switch-over to batteries if line voltage fails.

Operating Temperature: Operating 0°C to 50°C. Charging 0°C to 40°C, mainframe not operating.

Power Requirements: Charging power via 5300 mainframe nominal 7.5 watts.

Weight: Net 5 lbs. (2.3 kg). Shipping 6-1/4 lbs. (2.9 kg).

Dimensions: When battery pack is installed between 5300 mainframe and plug-on module. Overall height is increased by 1.5 inches (38.4 mm).

**WARRANTY: BATTERIES ARE NOT WARRANTED.**

## SECTION II INSTALLATION

### 2-1. INTRODUCTION

2-2. This section provides instructions for unpacking, inspection, preparation for use, storage, and shipment.

### 2-3. UNPACKING AND INSPECTION

2-4. If the shipping carton is damaged, ask that the carrier's agent be present when the instrument is unpacked. Inspect the instrument for damage, such as, scratches, dents, broken knobs, etc. If the instrument is damaged or fails to operate when used with the associated plug-on, notify the carrier and the nearest Hewlett-Packard Sales and Service Office immediately. Operating procedures are located in Section IX and Sales and Service Offices are listed in Section VIII of this manual. Retain the shipping carton and the padding material for the carrier's inspection. The Sales and Service Office will arrange for the repair or replacement of the instrument without waiting for the claim against the carrier to be settled.

### 2-5. STORAGE AND SHIPMENT

2-6. **PACKAGING.** To protect valuable electronic equipment during storage or shipment always use the best packaging methods available. Your Hewlett-Packard Sales and Service Office can provide packaging material such as that used for original factory packaging. Contract packaging companies in many cities can provide dependable custom packaging on short notice. Here is one recommended packaging method:

The original container is a corrugated card-board box with 200 lbs. burst test (HP Part No. 921-1619). The instrument is secured and protected while in the box by a top and bottom molded frame of polystyrene foam (HP Part No. 9220-1545). Also included with the instrument is a plastic dust protection cover (HP Part No. 05300-80004).

2-7. **ENVIRONMENT.** Conditions during storage and shipment should normally be limited as follows:

- a. Maximum altitude: 25,000 feet.
- b. Minimum temperature: -40°F (-40°C).
- c. Maximum temperature: +167°F (+75°C).

### 2-8. POWER CONNECTION

(I.E.C. Approved) (International Electrotechnical Commission).

#### CAUTION

**Before plugging instrument into ac power line, be sure the line voltage selector slide switch is properly positioned and the correct fuse is installed.**

2-9. **LINE VOLTAGE.** The counter may be operated from either 95 to 130 or 190 to 260 Vac (48 to 440 Hz). The instrument is supplied with a 115V fuse; be sure to change this fuse for 230V operation (see Table 2-1).

Table 2-1. 115/230 Volt Conversion

	115V (95-130)	230V (190-260)
Slide Switch	115	230
AC Line Fuse	.3 Amp slow-blow (HP 2110-0044)	.15 Amp slow-blow (HP 2110-0320)

2-10. The unit is shipped ready for 95 to 130 Vac operation; check the line voltage in use prior to applying ac power to the unit. To change the 115V/230V switch and the fuse proceed as follows:

At rear of unit:

- a. Disconnect power cord from unit.
- b. Press and turn FUSE knob counterclockwise and remove the fuse.
- c. Replace fuse with one of correct rating. (See back panel.)
- d. On bottom of unit slide the **LINE VOLTAGE** selector switch to the correct voltage with a screwdriver in the slot.

#### CAUTION

**If "115" is visible on the LINE VOLTAGE selector switch, 95 to 130 volts line voltage must be used. If "230" is visible, 190 to 260 line voltage must be used.**

- e. Continue with installation.

2-11. **POWER CABLE.** The instrument is equipped with a detachable 3-wire power cable. Refer to

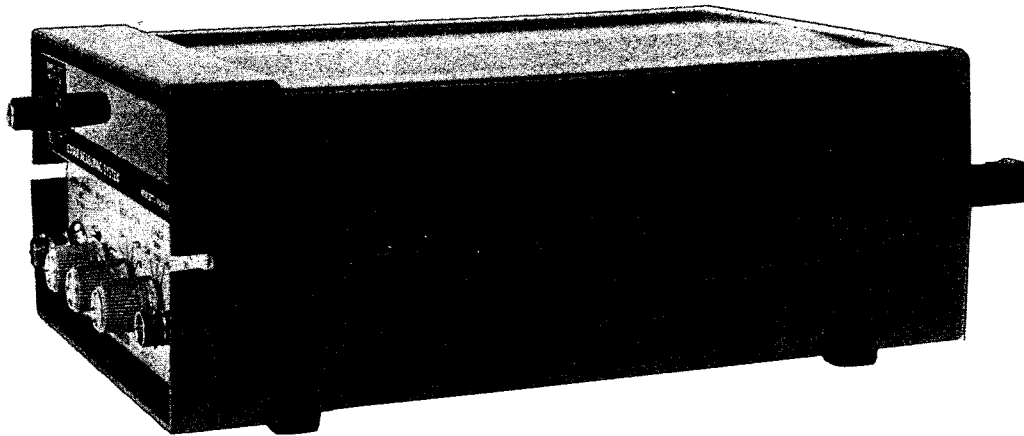

STEP A

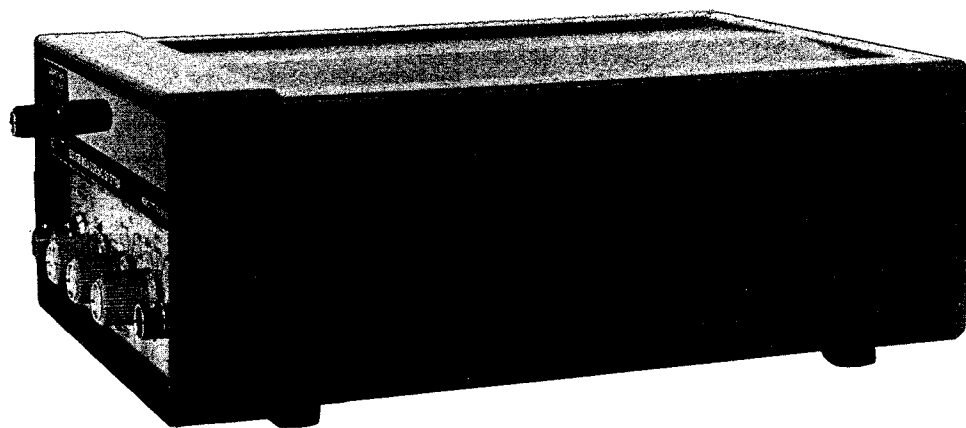

STEP B

Figure 2-1. Plug-On Installation

CAUTION NOTE in Paragraph 2-8, then install cable as follows:

a. Connect the plug (3-socket connector) to ac line receptacle at the rear of the instrument. Check that fuse and voltage settings are correct.

b. Connect the plug (2-blade with round ground pin) to 3-wire (grounded) power outlet.

#### NOTE

See alternate power cable description in paragraph 2-20.

2-12. Instrument chassis is grounded through the round pin on the plug; if a two-blade outlet must be used, attach a connector adapter (HP Part No. 1251-0048) to the power cable, then connect the short wire from side of the adapter to the ground.

### 2-13. INSTALLATION AND REMOVAL OF PLUG-ON MODULES

2-14. The 5300 Measuring System must be used with a mating plug-on before any measurements can be made. To mate the 5300 Measuring System with a plug-on, use Figure 2-1, Steps A and B, and proceed as follows:

a. Disconnect ac power and set the plug-on (on its feet) on a flat surface with the front-panel facing you.

b. Turn the 5300 right-side up with front panel facing you (ON-OFF-SAMPLE RATE on left side) and slide the side-casting latches all the way to the rear of the unit. The latch handles must be pressed gently away from the center of the unit to "unlock" them before sliding them rearward.

c. With latch handles fully extended rearward, mate the 5300 to the plug-on by placing the 5300 on top of the plug-on.

d. With the latches fully extended rearward and the 5300 properly positioned on the plug-on, an equal space should be visible (about 1/8-inch wide) where castings meet.

#### CAUTION

In the following step, DO NOT force latches forward; if difficulty is encountered, check latches and castings for obstructions.

e. Press down gently on top of 5300 casting and push the left and right latches forward. Castings will be brought together.

f. Check the position of the latches to ensure that castings are properly mated and latched. When properly latched, latches should not protrude past rear-edge of casting and there should be a paper-thin space between plug-on and 5300.

g. To separate the 5300 from the plug-on, pull the two-side casting latches fully rearward, (again it is necessary to press the latch handles gently away from the center of the instrument to unlock them).

h. When latches are fully extended rearward, the 5300 and plug-on castings should be separated by about 1/8-inch.

i. Lift 5300 gently away from plug-on.

### 2-15. PORTABLE OPERATION

2-16. The HP Model 5310A Battery Pack enables the Measuring System to be used in areas removed from ac power sources. The Battery Pack provides up to 8 hours portable operating time before recharging. Tables 1-2 and 1-4 list the HP 5310A Battery Pack as an available accessory. Documentation is also included in Section IV through VIII of this manual.

2-17. To prepare the 5300 for portable operation, turn POWER to OFF (full ccw), disconnect ac power cord, refer to Figure 2-2 and proceed as follows:

a. Set the plug-on, on its feet, on a flat surface with the front-panel facing you.

b. Turn the 5310A Battery Pack right-side up (LOW BATTERY LAMP on the left) with front-panel facing you and slide the side-casting latches all the way to the rear of the unit. The latch handles must be pressed gently away from the center of the unit to "unlock" them before sliding them rearward.

c. With the latches extended rearward, mate the plug-on to the 5310A Battery Pack by placing the 5310A on top of the plug-on.

d. With the 5310A properly positioned on the plug-on and the latches fully extended rearward, an equal space should be visible (about 1/8-inch wide) where castings meet.

e. Press down gently on top of the 5310A and push the left and right latches forward. Castings will be brought together (see CAUTION in Paragraph 2-14).

f. Check the position of the latches to ensure that castings are properly mated and latched. When properly latched, latches should not protrude past rear-edge of casting and there should be a paper-thin space between plug-on and 5310A Battery Pack.



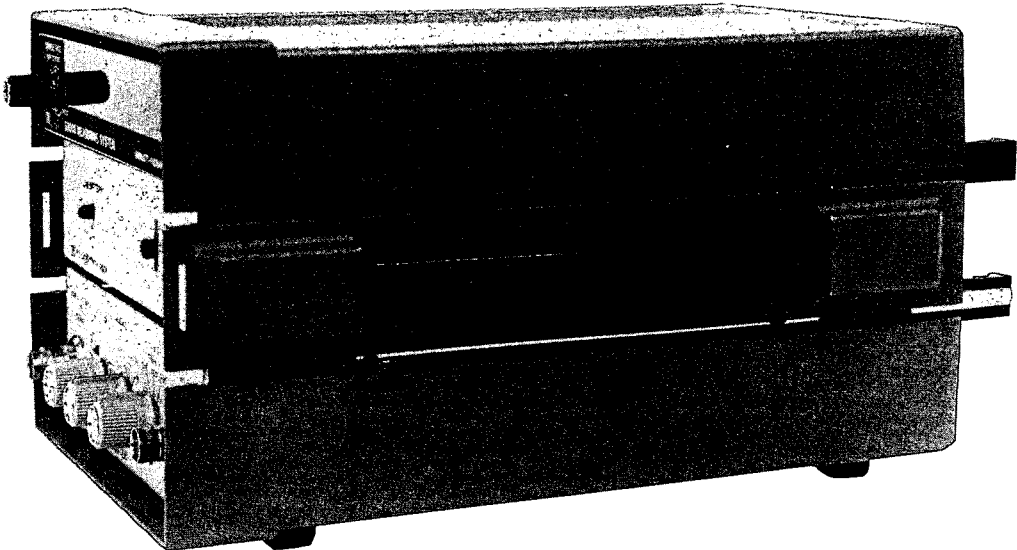

STEP A

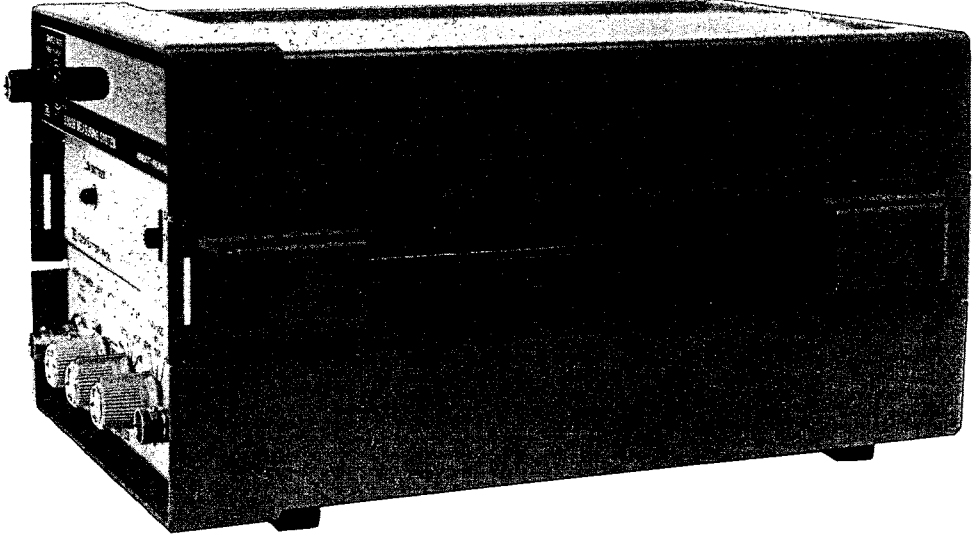

STEP B

Figure 2-2. Preparing for Portable Operation

g. Turn the 5300 right-side up with front-panel facing you and slide the side-casting latches all the way to the rear of the unit. The latch handles must be pressed gently away from the center of the unit to "unlock" them before sliding them rearward.

h. With latch handles fully extended rearward, mate the 5300 to the Battery Pack by placing the 5300 on top of the Battery Pack.

i. With the latches fully extended rearward and the 5300A properly positioned on the 5310A Battery Pack, an equal space should be visible (about 1/8-inch wide) where castings meet.

j. Press down gently on top of 5300 casting and push the left and right latches forward; castings will be brought together (see CAUTION in Paragraph 2-14).

k. Check the position of the latches to ensure that castings are properly mated and latched. When properly latched, latches should not protrude past rear-edge of casting and there should be a paper-thin space between 5310A Battery Pack and 5300.

l. When the selected plug-on, the 5310A Battery Pack and the 5300 Measuring System are interconnected and securely latched, perform the check-out procedure as follows:

1. Set 5310A BATTERY-LINE-CHARGE switch to BATTERY.
2. Turn 5300 power on and ensure that 5310A BATTERY LOW lamp is OFF.
3. If BATTERY LOW lamp is on, turn 5300 power off, connect ac power to 5300 and set 5310A BATTERY switch to CHARGE for 18 hours minimum. (See Section V, Paragraph 5-60.)

## CAUTION

**Maximum recharge time is 24 hours. Batteries may be damaged by heat if time limit is exceeded.**

4. If unit fails to operate, check interconnection of 5300, 5310A, and plug-on in use (if problem persists, refer to Section V, MAINTENANCE).

5. Refer to Section IX for the plug-on module used and perform the performance check procedures for that plug-on.

m. To separate the 5300, 5310A, and plug-on, pull the two side-casting latches on the 5300 fully rearward, (again it is necessary to press the latch handles gently away from the center of the unit to "unlock" them).

n. When latches are fully extended rearward, the 5300 and 5310A castings should be separated by about 1/8-inch.

o. Lift the 5300 gently way from the 5310A.

p. To separate the 5310A Battery Pack from the plug-on, repeat steps m, n, and o.

## 2-18. MAINTENANCE

2-19. All Maintenance information is contained in Section V.

## 2-20. ALTERNATE POWER CABLES

2-21. To accommodate the different power receptacles used throughout the world, this instrument is supplied with one of the power cables shown in Figure 2-3. The cable supplied for use in the United States meets the specifications established by the International Electrotechnical Commission (IEC). The male connector of this cable is a NEMA type and the female connector is a C.E.E. type.

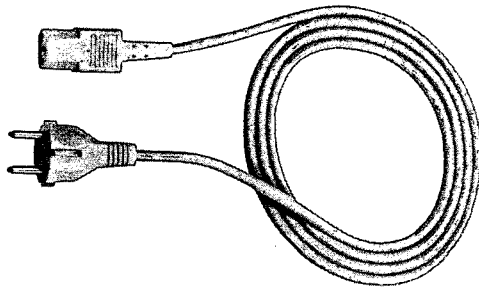

**POWER CABLE HP NO. 8120-1689**  
(Germany, France, Sweden, Netherlands,  
Yugoslavia, Belgium, Norway, Finland)

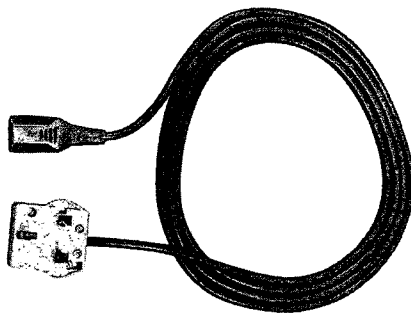

**POWER CABLE HP NO. 8120-1351**  
Great Britain

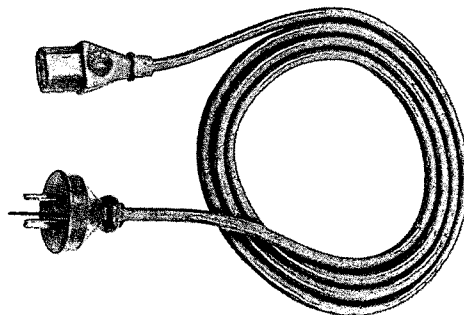

**POWER CABLE HP NO. 8120-1369**  
Australia, New Zealand

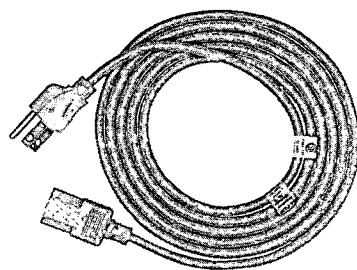

**POWER CABLE HP NO. 8120-1378**  
U.S.A., Canada

Figure 2-3. Power Cables

## SECTION III OPERATION

### 3-1. INTRODUCTION

3-2. Operation of the 5300B is simplified through the use of only one multiple-function control. By itself, the 5300B is not useable for measurements, therefore refer to the pertinent operating information for the associated plug-on in Section IX.

### 3-3. ACCURACY

3-4. The basic measuring accuracy is determined by

the plug-on module in use. Refer to Section IX for more information on specific plug-on accuracy.

### 3-5. FRONT PANEL

3-6. The 5300B front panel (Figure 3-1) contains the SAMPLE RATE control, which incorporates the power on-off (PWR OFF) function, the display-hold (HOLD) function, the LED display digit segments test, and the manual reset function. The eight-digit display and the display annunciators occupy the remainder of the front panel.

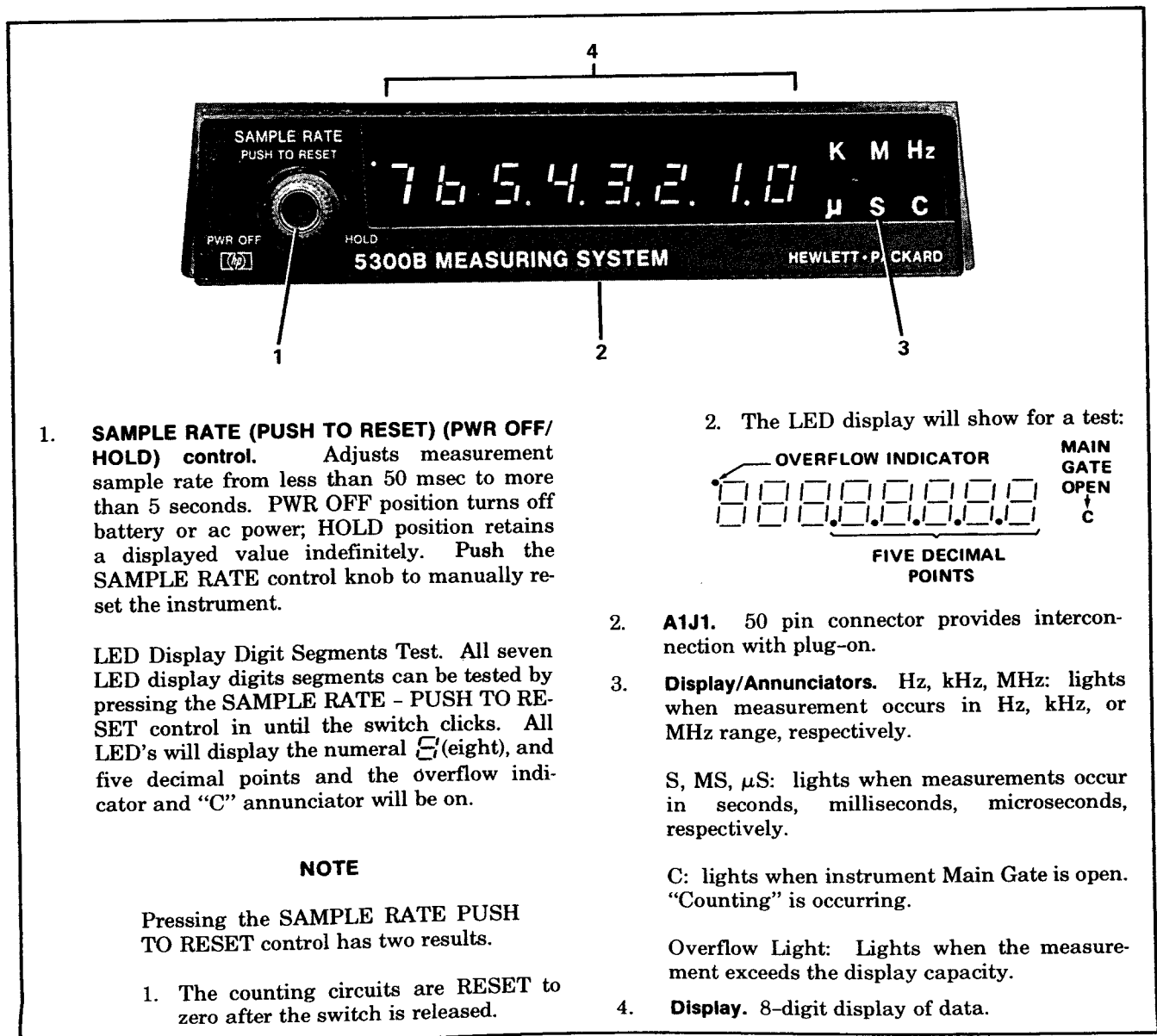

- SAMPLE RATE (PUSH TO RESET) (PWR OFF/HOLD) control.** Adjusts measurement sample rate from less than 50 msec to more than 5 seconds. PWR OFF position turns off battery or ac power; HOLD position retains a displayed value indefinitely. Push the SAMPLE RATE control knob to manually reset the instrument.

**LED Display Digit Segments Test.** All seven LED display digits segments can be tested by pressing the SAMPLE RATE - PUSH TO RESET control in until the switch clicks. All LED's will display the numeral 8 (eight), and five decimal points and the overflow indicator and "C" annunciator will be on.

#### NOTE

Pressing the SAMPLE RATE PUSH TO RESET control has two results.

- The counting circuits are RESET to zero after the switch is released.

- The LED display will show for a test:

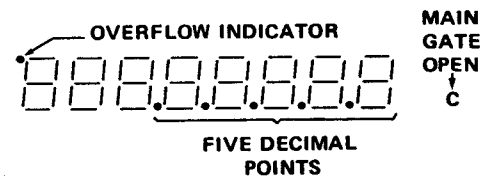

- A1J1.** 50 pin connector provides interconnection with plug-on.
- Display/Annunciators.** Hz, kHz, MHz: lights when measurement occurs in Hz, kHz, or MHz range, respectively.

S, MS,  $\mu$ S: lights when measurements occur in seconds, milliseconds, microseconds, respectively.

C: lights when instrument Main Gate is open. "Counting" is occurring.

Overflow Light: Lights when the measurement exceeds the display capacity.

- Display.** 8-digit display of data.

Figure 3-1. Front Panel Controls and Indicators

### 3-7. REAR PANEL

3-8. The rear panel (Figure 3-2) contains the ac input power connector, the fuse, the external oscillator jack, and the oscillator frequency adjustment.

3-9. INT-EXT Switch. The INT-EXT switch located near the power transformer allows the use of an external 10 MHz frequency source instead of the internal oscillator.

### 3-10. 5300B OPERATING PROCEDURES

3-11. The operating procedures for the 5300 Measuring System and its plug-ons are located in the documentation supplied for the respective plug-on in Section IX. For example, the operating information for HP Model 5301A 10 MHz Counter is Section IXA. The operating information for the HP Model 5302A 50 MHz Universal Counter is Section IXB.

### 3-12. 5310A OPERATING PROCEDURES

3-13. Refer to paragraph 2-15 for 5310A Battery Pack installation and operating instructions.

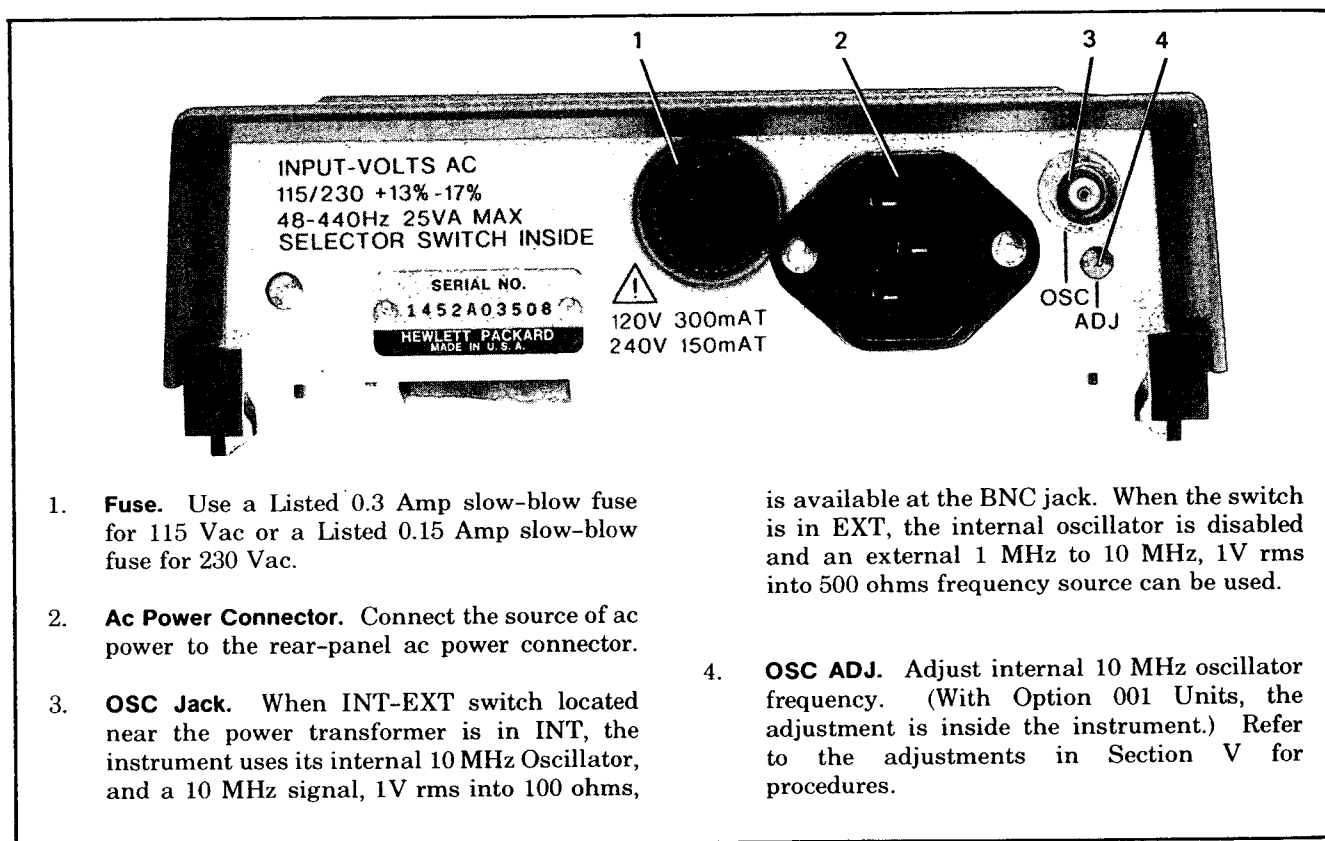

Figure 3-2. Rear Panel Connectors

## SECTION IV

### THEORY OF OPERATION

#### 4-1. INTRODUCTION

4-2. This section describes the theory of circuit operation from an overall viewpoint, then describes, in detail, the operation of the separate circuits. Each of the large-scale integrated circuits are described, and separate block diagrams are included to clarify their operation.

#### 4-3. OVERALL CIRCUIT OPERATION

4-4. Figure 4-1 is an overall block diagram of the Measuring System and a typical plug-on (5301A Plug-On). The Measuring System mainframe contains the major counting, timing, and display circuitry that is the basis of all measurements made with a mainframe/plug-on combination.

4-5. The functional modules of the mainframe are shown in the simplified block diagram of Figure 4-1. These are:

- a. Display — an eight-digit strobed solid-state LED display with required decoding and driving circuits.
- b. Counter — six-digit 10 MHz counting and storage register in one integrated circuit, and a separate decade counter, storage latch, and associated multiplexing circuits.
- c. Data Control Read-Only-Memory (ROM) (A1U5) — controls data multiplexing from the counters to the display.
- d. Time Base (A1U2) — an eight-decade 10 MHz, automatic time-base divider.
- e. Control (A1U9) — provide the basic control functions and gating for counting and timing measurement cycles, including auto-ranging, transfer, reset, and sample rate control.
- f. Time Base Reference Oscillator — 10 MHz crystal-controlled oscillator which provides the basic frequency and time references for the system.
- g. Power Supply — provides regulated voltages to the mainframe and all plug-on modules and charging power to the optional battery pack module. Power supply input can be 115 Vac or 230 Vac line voltage or dc power from the battery pack.

4-6. These functional blocks of the mainframe may be interconnected in several ways to provide different measurement capabilities. A typical system inter-

connected for frequency measurement is shown in the block diagram, Figure 4-1. The major signal and control lines are all routed through the plug-on connector, to the plug-on module, which determines measurement function as well as providing the input signal interfaces.

4-7. The four-wire data bus carries the system data between modules in a binary-coded-decimal, digit-serial format. Data can flow from the decade counters to the display and to the plug-on module, or from the plug-on module to the display. The transfer of data to the display is controlled by a 3-bit binary code (Digit Address) which is generated by the display scan circuits. A 3-bit code (Digit Select) controls the data output from the counter. With most plug-on modules the displayed information is the stored contents of the counter (A1U1, U3, and U6). In these modules, the digit address lines are wired directly to the digit select lines within the modules. If an HP 5306 Multimeter Counter is used with the mainframe (in any mode except the frequency mode), the Data Control Read-Only-Memory (ROM) alters the digit select code so that the least significant decade counter/latch (A1U3, A1U6) is not used. This forces a six-digit display, which is the maximum display possible using the multimeter/counter in the stated operating modes.

4-8. The A1U2 time base is also programmed by a 3-bit time base code which can select any time base division factor in powers of 10, from  $10^1$  to  $10^8$ . The time base output may also be selected automatically over the same range. In the auto-ranging mode the range is indicated by the number of exponent pulses generated by the time base and the control module. These pulses are counted, stored, and decoded by an exponent register in the plug-on module, which then provides the drive to the appropriate decimal point and units indicators in the mainframe.

4-9. The input signals to the counter and the time base are routed through the control circuit. For a typical frequency measurement, as shown in the block diagram, the F1 input to the counter is derived from the input amplifier of the plug-on module; and the time base input F2 is the reference frequency from the crystal oscillator. In a period average measurement, which is the reciprocal of frequency, these signals are reversed. In addition to the F2 input, a 1 MHz input to the time base is provided which bypasses the first time base decade and the control module and allows auto-ranging down to a single cycle of the input signal.

#### 4-10. DETAILED CIRCUIT OPERATION

4-11. The following paragraphs describe detailed operation of each of the functional circuit segments in the mainframe.

Models 5300B and 5310A  
Theory of Operation

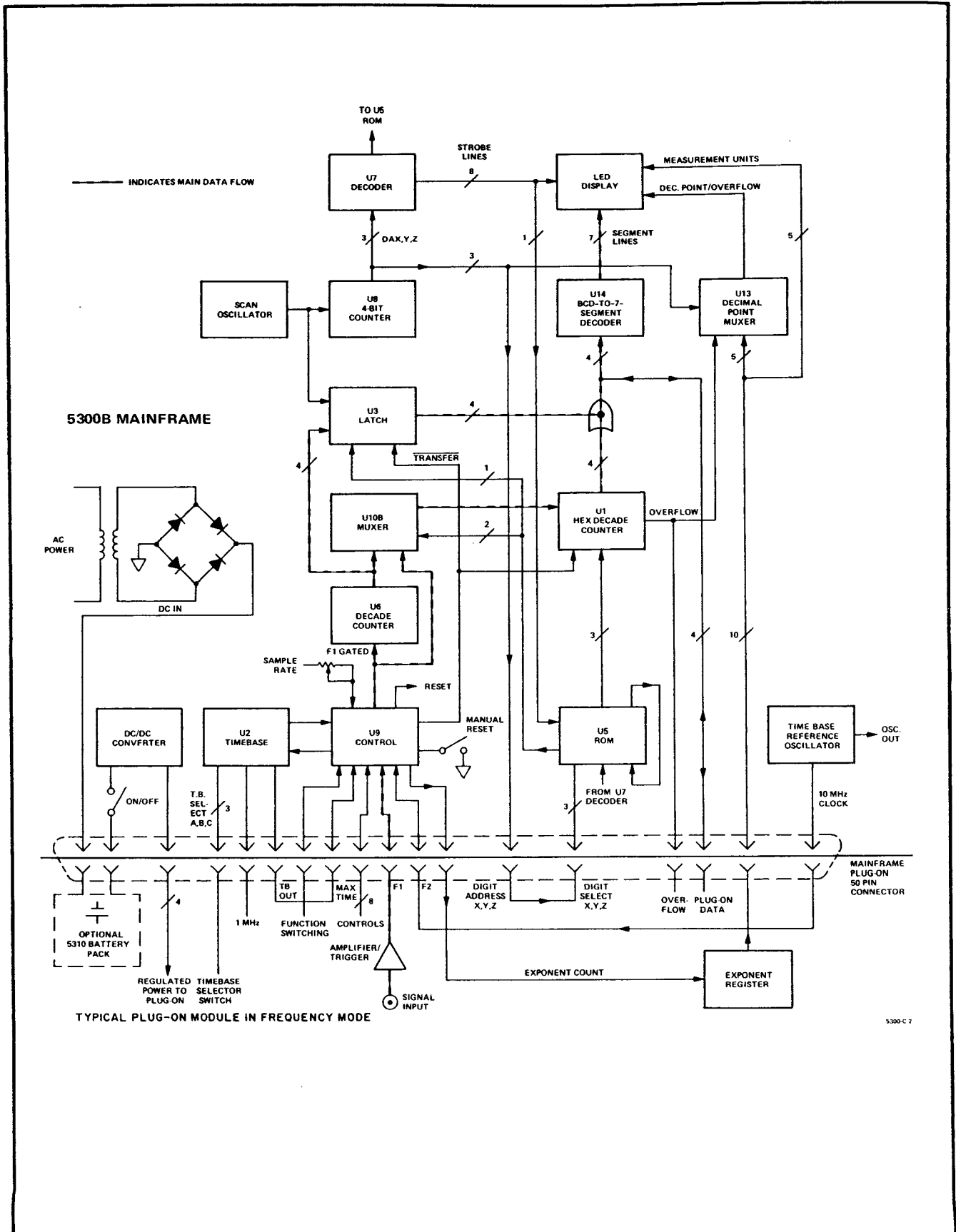

Figure 4-1. Simplified Block Diagram

#### 4-12. Eight-Digit Display

4-13. The display is an 8-digit, scanned, LED display. Each digit is formed from seven diode segments, which emit red light when forward current passes through the diodes.

4-14. In operation, the scan oscillator (three inverters in integrated circuit A1U12) generates a scan rate signal with a frequency of approximately 8 kHz. This signal is counted by 4-bit counter A1U8. The three most significant output bits of A1U8 (Digit Address X, Y, and Z) are decoded into eight separate drive lines by A1U7 decoder. Each drive line enables one of the eight display digits. With an 8 kHz scan oscillator frequency, the complete display is scanned, one digit after another, in approximately two milliseconds.

4-15. The Digit Address X, Y, and Z lines are also sent to the accessory measurement plug-on and return to the mainframe as the Digit Select X, Y, and Z lines. After modification by A1U5 Data Control ROM (see following paragraphs for detailed operation), these lines control the multiplexing of data onto the data bus, the Data A, B, C, and D lines. The BCD-to-Seven Segment Decoder A1U14 converts the BCD data from the counters to the seven-segment code necessary to drive the display. Data is supplied to all eight display digits at once, but the outputs of A1U7 decoder enable only the single display position that corresponds to the four bits of data on the data lines at a given time.

4-16. The decimal point multiplexer, A1U13, accepts inputs from each decimal point drive line, from the MGFF signal line (which is used to light the front-panel "C" annunciator), and from the counter overflow line. The multiplexer output drives all the decimal points and the C (gate) lamp simultaneously, but each indicator is enabled separately at the time that the corresponding display digit is enabled. For example, if the DP2 (decimal point 2) drive line from the plug-on is low, the A1U13 multiplexer output will go low at digit address code 2 (L H L for DA Z, Y, and X lines, respectively). At the same time, A1U7 decoder enables display digit DS6 via A1Q7. Although all decimal points are driven together by the single multiplexer output line, only decimal point 2 (associated with display digit DS6) is enabled at this time in the scan cycle.

4-17. When an HP 5306 Multimeter/Counter measures negative dc voltages, the data code for a minus sign (H H L L for Data D, C, B, and A respectively) appears on the data lines when the digit address code is five (H L H on the DA Z, Y, and X lines, respectively). The minus sign detector (A1U15 A, B, and C) detects the code for a minus sign and, via transistor A1Q15, pulls pin 14 of A1U14 low. This places a minus sign (segment g illuminated) in the third most significant display position, DS3.

#### 4-18. Counter

4-19. The counter consists of A1U1 hex-decade counter circuit, A1U6 single decade counter, A1U3 latch, and A1U10B which functions as a multiplexer.

### CAUTION

The A1U1 counter is a large-scale MOS integrated circuit. Its inputs are susceptible to damage by high voltages (+5.6 volts) and static charges. Particular care should be exercised when servicing this circuit or handling it under conditions where static charges can build up.

4-20. The A1U1 counter consists of six decade-counting elements, an overflow register, a 25-bit latch, and output multiplexing circuits. Figure 4-2 is a basic block diagram of A1U1. The counter can accumulate and store up to 1 million pulses at its input. The input triggers on the positive-going edge of the input pulse, which is derived from the control circuit, A1U9. The A1U9 input signal is the F1 signal from the plug-on. The TRANSFER input at A1U1(4) transfers data from the decade counters to the latch circuits when the TRANSFER line is low. When the TRANSFER line is high, data is stored in the latch circuits. The RESET input at pin 11 resets the decades when the RESET signal is high. One million or more input counts into the counter sets the overflow register, which causes the OVERFLOW output at pin 7 to go high following a TRANSFER signal.

4-21. The counter output is available one-digit at a time as a four-bit, binary-coded-decimal signal (logical 1 is high). The digit selected at the output is determined by the binary-coded X, Y, and Z lines at pins 8, 9, and 10. Binary 0 (all low) selects the least significant decade. Binary 5 selects the most significant decade in the register. A code of binary 6 or 7 will set all outputs high which allows other data from the plug-on or from high-speed decade A1U6 to be inserted in place of the counter data. If no other data is presented, the display remains blank. When a count of 90,000 has been registered in the counter (decades 0 to 4), the output labelled "9" goes low. This signal is used during auto-ranging, to register a reading of 9% or greater of full scale.

4-22. The high-speed decade counter, A1U6, normally divides the measured signal before the signal is applied to A1U1 counter circuit. An exception is when the measurement plug-on is an HP 5306 Multimeter/Counter operating in certain modes. See the following paragraphs for information about how the ROM outputs control the counter address lines and the A1U3 latch control lines.



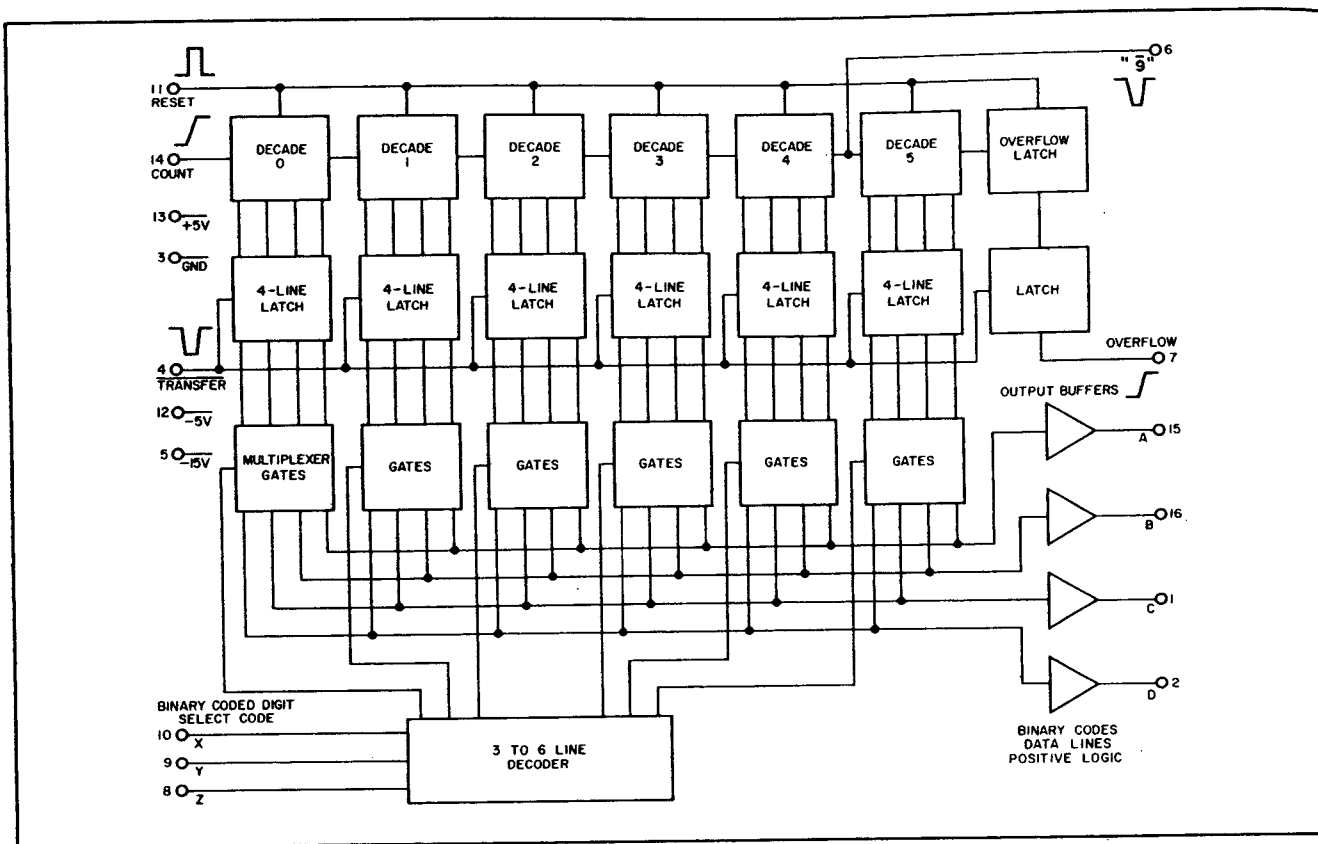

Figure 4-2. A1U1 6-Decade Counter Block Diagram

#### 4-23. Data Control ROM

4-24. The data control ROM, A1U5, performs three basic functions: (1) alters the digit select codes from a measurement plug-on, and therefore, controls the multiplexing of data from the counter circuits to the display circuits, (2) supplies control signals to A1U3 latch and A1U10B multiplexer, and (3) generates a minus sign control signal when a 5306 Multimeter/Counter is used to measure negative dc voltages. The following paragraphs and Tables 4-1, 4-2, 4-3, and 4-4 describe each of these functions.

4-25. The digit select code from the plug-on supplies three of the five A1U5 ROM address bits (inputs D, C, and B). With all plug-ons except the 5306 Multimeter/Counter, address bit A is high, and address bit E is high except when the digit address code is five. Under these operating conditions, the ROM decrements the digit select code by one and supplies the resulting X, Y and Z code (outputs Y2, Y3, and Y6, respectively) to the data counter address inputs. ROM output Y7 enables the outputs of latch A1U3 when the digit select code is zero except when a 5306 is used to measure ohms or volts. The X, Y, and Z ROM outputs supply a code of seven at this time, which causes all data outputs of A1U1 hex-decade counter to be high, and allows the A1U3 latch outputs to control the data bus. When the digit select code

increments to one, the X, Y, and Z ROM outputs supply a code of zero to the hex-decade counter, and the Y7 ROM output disables the A1U3 latch outputs. The next five digit select codes multiplex data from the hex-decade counter to the display circuits.

4-26. If a 5306 Multimeter/Counter is used in ohms or volts modes, the ROM does not decrement the digit select code by one. The presence of a 5306 is detected by the ROM because the 5306 is the only plug-on that supplies a digit select code of six or seven to the mainframe when the digit address code to the plug-on is five. When this occurs, the A input line to the ROM goes low, and, consequently, a new set of ROM locations are addressed. Tables 4-1 through 4-4 will clarify operation for any given plug-on or operating circumstances.

#### 4-27. Time Base

### CAUTION

The time base is a large-scale MOS integrated circuit. Its inputs are susceptible to damage by high voltages and static charges. Particular care should be exercised when servicing this circuit or handling it under conditions where static charges can build up.

Table 4-1. A1U5 Data Control ROM Listing

PIN #	INPUTS						OUTPUTS								
	14	13	12	11	10	15	9	7	6	5	4	3	2	1	
LABEL	E	D	C	B	A	Enable	Y8	Y7	Y6	Y5	Y4	Y3	Y2	Y1	
FUNCTION	DIG 5	DS X	DS Y	DS Z	5306	Reset	5306	LE	Z	U6	U6	Y	X	Minus	
0	L	L	L	L	L	L	L	H	L	L	H	L	L	L	
1	L	L	L	L	H	L	H	L	H	H	L	H	H	H	
2	L	L	L	H	L	L	L	H	H	L	H	L	L	L	
3	L	L	L	H	H	L	H	H	L	H	L	H	H	H	
4	L	L	H	L	L	L	L	H	L	L	H	H	L	L	
5	L	L	H	L	H	L	H	H	L	H	L	L	H	H	
6	L	L	H	H	L	L	L	H	H	L	H	H	L	H	
7	L	L	H	H	H	L	L	H	H	H	L	L	H	H	
8	L	H	L	L	L	L	L	H	L	L	H	L	H	L	
9	L	H	L	L	H	L	H	H	L	H	L	L	L	H	
10	L	H	L	H	L	L	L	H	H	L	H	L	H	L	
11	L	H	L	H	H	L	H	H	H	H	L	L	L	H	
12	L	H	H	L	L	L	L	H	L	L	H	H	H	L	
13	L	H	H	L	H	L	H	H	L	H	L	H	L	H	
14	L	H	H	H	L	L	L	H	H	L	H	H	H	H	
15	L	H	H	H	H	L	L	H	H	H	L	H	L	H	
16	H	L	L	L	L	L	L	H	L	L	H	L	L	L	
17	H	L	L	L	H	L	H	L	H	H	L	H	H	H	
18	H	L	L	H	L	L	L	H	H	L	H	L	L	L	
19	H	L	L	H	H	L	H	H	L	H	L	H	H	H	
20	H	L	H	L	L	L	L	H	L	L	H	H	L	L	
21	H	L	H	L	H	L	H	H	L	H	L	L	H	H	
22	H	L	H	H	L	L	L	H	H	L	H	H	L	L	
23	H	L	H	H	H	L	H	H	H	H	L	L	H	H	
24	H	H	L	L	L	L	L	H	L	L	H	L	H	L	
25	H	H	L	L	H	L	H	H	L	H	L	L	L	H	
26	H	H	L	H	L	L	L	H	H	L	H	L	H	L	
27	H	H	L	H	H	L	H	H	H	H	L	L	L	H	
28	H	H	H	L	L	L	L	H	L	L	H	H	H	L	
29	H	H	H	L	H	L	H	H	L	H	L	H	L	H	
30	H	H	H	H	L	L	L	H	H	L	H	H	H	L	
31	H	H	H	H	H	L	H	H	H	H	L	H	H	H	
ALL	X	X	X	X	X	H	H	H	H	H	H	H	H	H	

NOTE: Nonshaded ROM Words are used only with 5306 in voltage or resistance measurement modes.

**SIGNAL FUNCTIONS AND CONDITIONS:**

- INPUT A. High during normal operation, low when 5306 plug-on is used (except frequency mode). Controlled by Y8 output.
- INPUT B, C, and D. Driven by Digit Select Z, Y, and X, respectively (from plug-on).
- INPUT E. High during digit address zero through four and six and seven; low during digit address five.
- ENABLE INPUT. Normally low; goes high briefly during reset cycle (while digit 5 is displayed) and sets all ROM outputs high.
- OUTPUT Y1. Y1 stays high with most plug-on units. With the 5306 in any mode except FREQ Y1 is normally low, and it goes high only at Digit Address 5. The high at Digit Address 5 enables the minus sign to be displayed.
- OUTPUT Y2, Y3, and Y6. Supplies X, Y, and Z address lines, respectively, to data counter address inputs.
- OUTPUT Y4 and Y5. Control multiplexer A1U10B. Normally Y4 is low, Y5 is high and measured signal is first counted in A1U6 decade counter. The output of A1U6 is applied to A1U1 hex-decade counter. When 5306 is used in any mode except frequency, Y4 is high, Y5 is low and A1U10B multiplexer routes measured signal directly to A1U1 hex-decade counter (Y4 = Y5).
- OUTPUT Y7. Goes low at digit select code zero (except when 5306 is used in volts or ohms modes) to allow output of A1U3 latch to be placed on data lines.
- OUTPUT Y8. Drives address input A. Normally high, but goes low when 5306 is used in any mode except frequency.

Table 4-2. ROM Sequences for 5301A, 5302A, 5304A, 5306A (Frequency Measurements),  
and 5307A Plug-Ons

PIN #	INPUTS						OUTPUTS								ENABLED DISPLAY DIGIT	
	14	13	12	11	10	15	9	7	6	5	4	3	2	1		
LABEL	E	D	C	B	A	Enable	Y8	Y7	Y6	Y5	Y4	Y3	Y2	Y1		
FUNCTION	DIG 5	DS X	DS Y	DS Z	5306	Reset	5306	LE	Z	U6	U6	Y	X	Minus		
W O R D	17	H	L	L	L	H	L	H	L	H	H	L	H	H	H	0 (LSD)
	25	H	H	L	L	H	L	H	H	L	H	L	L	L	H	1
	21	H	L	H	L	H	L	H	H	L	H	L	L	H	H	2
	29	H	H	H	L	H	L	H	H	L	H	L	H	L	H	3
	19	H	L	L	H	H	L	H	H	L	H	L	H	H	H	4
	11	L	H	L	H	H	L	H	H	H	H	L	L	L	H	5
	23	H	L	H	H	H	L	H	H	H	H	L	L	H	H	6
31	H	H	H	H	H	L	H	H	H	H	L	H	L	H	7 (MSD)	

NOTES: 1) With these plug-ons, the digit select code from the plug-on is the same as the digit address code sent to the plug-on. Therefore, the binary digit select code corresponds directly to the digit being displayed.

2) The high-speed decade in the mainframe (A1U6) always supplies the least-significant display data; the most-significant display position is always blanked.

Table 4-3. ROM Sequences for 5303B, 5305A, and 5308A Plug-Ons

PIN #	INPUTS						OUTPUTS								ENABLED DISPLAY DIGIT	
	14	13	12	11	10	15	9	7	6	5	4	3	2	1		
LABEL	E	D	C	B	A	Enable	Y8	Y7	Y6	Y5	Y4	Y3	Y2	Y1		
FUNCTION	DIG 5	DS X	DS Y	DS Z	5306	Reset	5306	LE	Z	U6	U6	Y	X	Minus		
W O R D	31	H	H	H	H	H	L	H	H	H	H	L	H	L	H	0 (LSD)
	17	H	L	L	L	H	L	H	L	H	H	L	H	H	H	1
	25	H	H	L	L	H	L	H	H	L	H	L	L	L	H	2
	21	H	L	H	L	H	L	H	H	L	H	L	L	H	H	3
	29	H	H	H	L	H	L	H	H	L	H	L	H	L	H	4
	3	L	L	L	H	H	L	H	H	L	H	L	H	H	H	5
	27	H	H	L	H	H	L	H	H	H	H	L	L	L	H	6
23	H	L	H	H	H	L	H	H	H	H	L	L	H	H	7 (MSD)	

NOTES: 1) These plug-ons subtract one from the digit address code and supply the resulting digit select code to the mainframe. The ROM subtracts one more unit from the digit select code and uses the resulting binary code (X, Y, and Z) to address the decade data counters. This allows one decimal display digit to be supplied from the plug-on (displayed in display digit 0), the high-speed mainframe decade (A1U6) to be displayed in display digit 1, and the six-decade counter (A1U1) to be displayed in display digits 2 through 7.

Table 4-4. ROM Sequence for 5306A Plug-On (Volt and Ohm Measurements)

		INPUTS						OUTPUTS								ENABLED DISPLAY DIGIT
PIN #		14	13	12	11	10	15	9	7	6	5	4	3	2	1	
LABEL		E	D	C	B	A	Enable	Y8	Y7	Y6	Y5	Y4	Y3	Y2	Y1	
FUNCTION		DIG 5	DS X	DS Y	DS Z	5306	Reset	5306	LE	Z	U6	U6	Y	X	Minus	
W O R D	16	H	L	L	L	L	L	L	H	L	L	H	L	L	L	0 (LSD)
	24	H	H	L	L	L	L	L	H	L	L	H	L	H	L	1
	20	H	L	H	L	L	L	L	H	L	L	H	H	H	L	2
	28	H	H	H	L	L	L	L	H	L	L	H	H	H	L	3
	18	H	L	L	H	L	L	L	H	H	L	H	L	L	L	4
	14	L	H	H	H	L	L	L	H	H	L	H	H	H	H	5
	22	H	L	H	H	L	L	L	H	H	L	H	H	L	L	6
	30	H	H	H	H	L	L	L	H	H	L	H	H	H	L	7 (MSD)
ABOVE SEQUENCE OCCURS WHEN "FAST" BUTTON IS DEPRESSED																
W O R D	24	H	H	L	L	L	L	L	H	L	L	H	L	H	L	0 (LSD)
	20	H	L	H	L	L	L	L	H	L	L	H	H	L	L	1
	28	H	H	H	L	L	L	L	H	L	L	H	H	H	L	2
	18	H	L	L	H	L	L	L	H	H	L	H	L	L	L	3
	26	H	H	L	H	L	L	L	H	H	L	H	L	H	L	4
	6	L	L	H	H	L	L	L	H	H	L	H	H	L	H	5
	30	H	H	H	H	L	L	L	H	H	L	H	H	H	L	6
	22	H	L	H	H	L	L	L	H	H	L	H	H	L	L	7 (MSD)

ABOVE SEQUENCE OCCURS WHEN "FAST" BUTTON IS NOT DEPRESSED

- NOTES: 1) With these operating conditions, the ROM X, Y, and Z outputs are the same as the digit select code from the plug-on.
- 2) The ROM detects a 5306 plug-on in these operating modes, because the plug-on responds to a digit address code of 5 (A1U5, pin 14 goes low at this time) with a returned digit select code of binary 6 or 7. This causes output Y8 (A1U5, pin 9) to go low and latches the ROM into the sequences shown above.

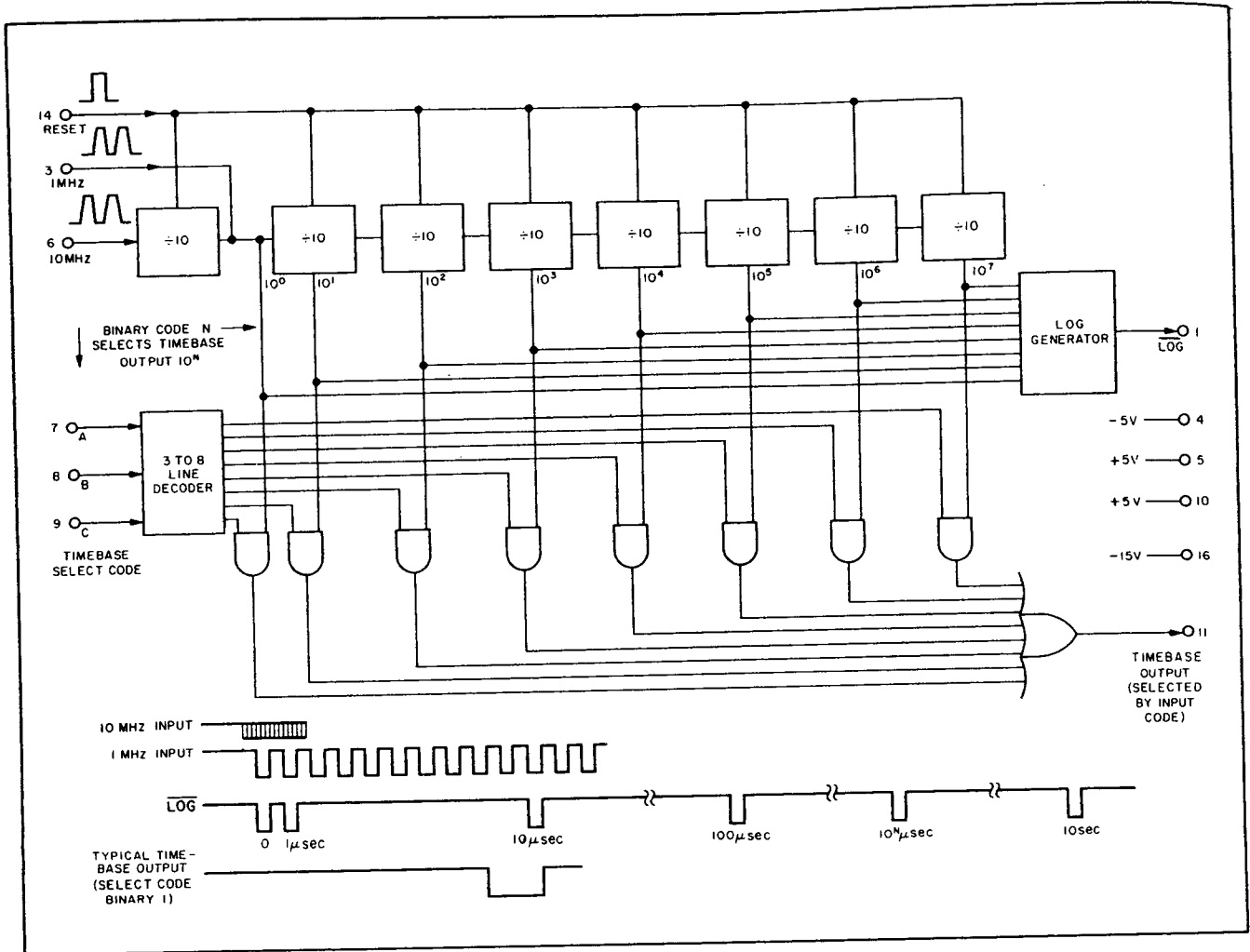

Figure 4-3. A1U2 Time Base Block Diagram

4-28. The A1U2 Time Base is a large scale integrated circuit containing eight decade-divider elements. Figure 4-3 shows a basic block diagram. It accepts a maximum input frequency of 10 MHz which gives an output of one pulse every 10 seconds from the last decade-divider. The outputs of all decade dividers are multiplexed into a single time-base output line at A1U2(11). The number of stages used to divide the input signal is determined by a 3-bit binary-coded select code (pins 7, 8, and 9). Division factors of  $10^1$  through  $10^8$  can be selected. The first decade stage may be bypassed by a second input whose maximum frequency is 1 MHz. This input can be divided by scaling factors of 1 through  $10^7$ . The precision timing and auto-ranging required for frequency and period average measurements is provided by the LOG output at pin 1. During the first 10 seconds of a frequency measurement following reset this output provides only 9 pulses. The first pulse triggers the gate opening at time 0, thereafter pulses are obtained at 1, 10, and 100  $\mu$ sec, 1, 10, and 100 msec, 1 sec, and 10 sec. During auto-ranging,

one of these pulses is automatically selected to trigger the gate closing. After the measurement is in progress, each pulse is precisely referenced to the Start Pulse at time 0, which enables the Stop Pulse to be selected. The time base can be cleared to zero by a positive reset pulse at pin 14.

TIME BASE CODE/U2

GATE TIME	TBC	TBB	TBA
1 $\mu$ s	0	0	0
10 $\mu$ s	0	0	1
.1 ms	0	1	0
1 ms	0	1	1
10 ms	1	0	0
.1 S	1	0	1
1 S	1	1	0
10 S	1	1	1

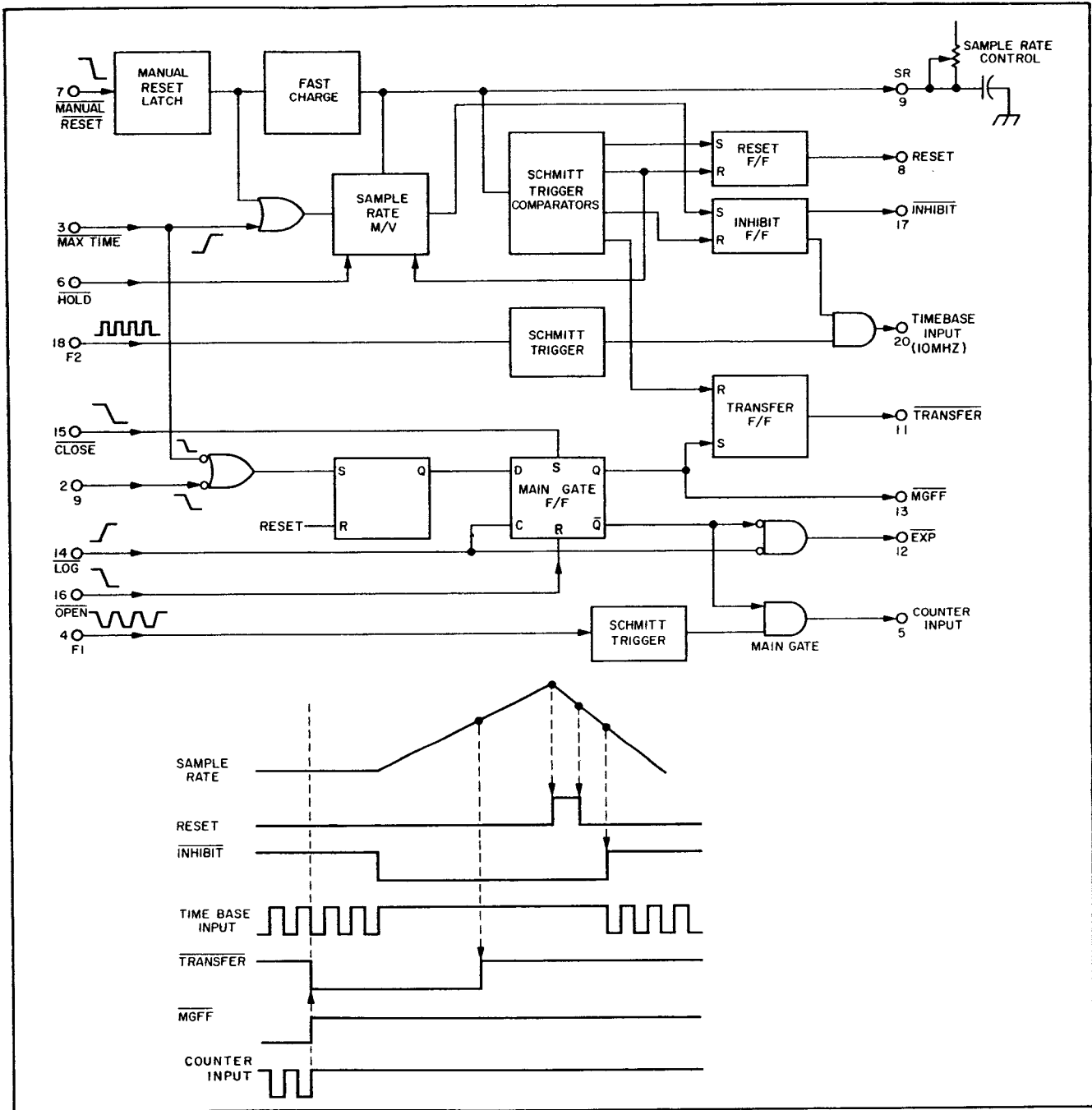

Figure 4-4. A1U9 Control Block Diagram

**4-29. A1U9 Control**

4-30. The signal gating and measurement cycle control for the measuring system is provided by A1U9 Control integrated circuit. Figure 4-4 shows a basic block diagram. The functions provided are: gating of signals to the counter and time base, sample rate control, and provision for RESET and TRANSFER signals.

4-31. The F1 and F2 inputs are shaped by Schmitt-

triggers and then gated to pins 5 and 20 as the TIME BASE INPUT and COUNTER INPUT signals. To maintain optimum drive to the MOS circuits, these outputs are not routed through the plug-on. During reset, F1 remains at a high state until the opening of the gates.

**NOTE**

Particular care should be taken during servicing to avoid excessive capacitive loading of these outputs with probes.

4-32. The Main Gate flip-flop controls gating of the counted signals. The flip-flop can be set or reset by low signals at the OPEN (pin 16) or CLOSE (pin 15) inputs, or can be triggered by a positive-going edge at the LOG input (pin 14) which comes from the time base. Following reset, the first LOG input pulse opens the gate. Subsequent LOG inputs will not affect the flip-flop until the D input is driven from an enabling flip-flop which is set by the low signal at either the "9" input or the MAX TIME input. Setting this flip-flop enables the next LOG pulse to close the Main Gate and terminate the measurement.

4-33. During manual operation, the MAX TIME signal enables the closing of the gate at the predetermined gate time. During automatic operation after the counter has reached 9% of full scale, the "9" input enables the closing of the gate on the following LOG pulse, which always occurs before 90% full scale is reached. The number of LOG pulses occurring while the main gate is open appears at the EXP output (pin 12). This number of pulses indicates the number of ranges through which the time base has automatically stepped and is used to determine the correct decimal point and units indication.

4-34. As soon as the main gate closes, a Transfer flip-flop triggers to provide a low output to transfer data from the counter to the display. The display cycle is initiated by the rising edge at the MAX TIME input which triggers the Sample Rate M.V. The sample rate capacitor begins charging through the front-panel SAMPLE RATE control. At a point approximately halfway up the charging curve, the TRANSFER signal is removed. When the peak charging voltage is reached, the Reset flip-flop triggers, providing a high signal at the RESET output. At this point the discharge of the sample rate capacitor is initiated. The discharge time is a few milliseconds. At a point halfway down the discharge curve, the RESET signal is removed.

4-35. At the beginning of the display cycle, the time base input is gated off by an Inhibit flip-flop. The INHIBIT signal is removed at the end of the capacitor discharge. The time base input is then gated on, beginning a new measurement cycle. An INHIBIT signal is available to the plug-on, providing a low signal during the display cycle. The displayed information may be displayed indefinitely by switching to the HOLD position on the front panel. This opens the charging potentiometer circuits to the sample rate capacitor and prevents the capacitor from charging up. The front-panel PUSH to RESET switch supplies a low MANUAL RESET signal to clear the display.

#### 4-36. Time Base Reference Oscillator

4-37. Gate A1U4B, crystal A1Y1, and associated components operate as a 10 MHz oscillator. Minor frequency adjustments are made by adjusting capacitor

A1C10 and A1C11. The oscillator output passes through buffer gate A1U4A, whose complementary outputs drive differential transistor pair A1Q10 and A1Q11. The differential pair converts the ECL logic levels of the oscillator to levels suitable to drive following TTL circuits; the duty cycle of the resulting signal is set by resistor A1R25. After being buffered by the inverters within A1U11, the 10 MHz signal is supplied to the rear-panel OSC connector and to A1J1, the plug-on attaching connector. An external oscillator signal may be connected to the rear-panel connector, and after being buffered by A1U11 it is applied, in place of the internal oscillator, to the plug-on.

#### 4-38. Power Supply

4-39. The power supply is a small, high efficiency power converter capable of supplying the necessary output voltages for the analog circuits, Light-Emitting-Diode (LED) Display, and digital circuits (see Figure 4-5). The unit will operate from 115 Vac or 230 Vac, 50 to 400 Hz or from an accessory battery pack, such as the HP 5310A, which has nominal output voltage of 12V.

4-40. Input power, 115 Vac or 230 Vac, is stepped down by T1 and rectified by bridge rectifiers A1CR1, CR5, CR6, and CR7. Capacitor A1C5 protects these rectifiers from high voltage transients in T1, and A1R8 prevents A1C5 from charging to an excessively high voltage. The dc output voltage from the bridge rectifiers is nominally +22 volts, when fully loaded by the mainframe dc-to-ac converter and the battery pack under CHARGE conditions.

4-41. The dc-to-ac converter is a blocking oscillator converter using a single switching transistor, A1Q17, with the dc input voltage available across A1C6. Resistor A1R35 supplies initial start current into the base of A1Q17 to start oscillations. Diode A1CR9 allows base current to flow to A1Q17 during normal operation with capacitor A1C23 as an ac bypass. Printed circuit wiring is such that no drive voltage is applied to A1Q17 if A2 Regulator Assembly is removed from its socket. During normal operation A1Q17 alternately switches on into saturation and then off. With A1Q17 "on", an increasing current flows through A1T1 and the primary of A1T2.

4-42. The polarity of the rectifiers on the secondary of A1T2 is such that when A1Q17 is turned on, they do not conduct. Thus, the dc input voltage sees only the primary inductances of A1T1 and A1T2. A1T1 is a small current transformer and drops very little voltage across primary pins 1 and 3. A1Q17 collector current builds up linearly when it is turned on. The impedance of A1T1 is such that about 1/15th the A1Q17 collector current flows into the base of A1Q17. This is sufficient to keep it in saturation. After a period of time, designated time T1 and controlled by the rest of the circuit (Figures 4-5 and 4-6), A1Q17 switches off. The magnetic energy stored in

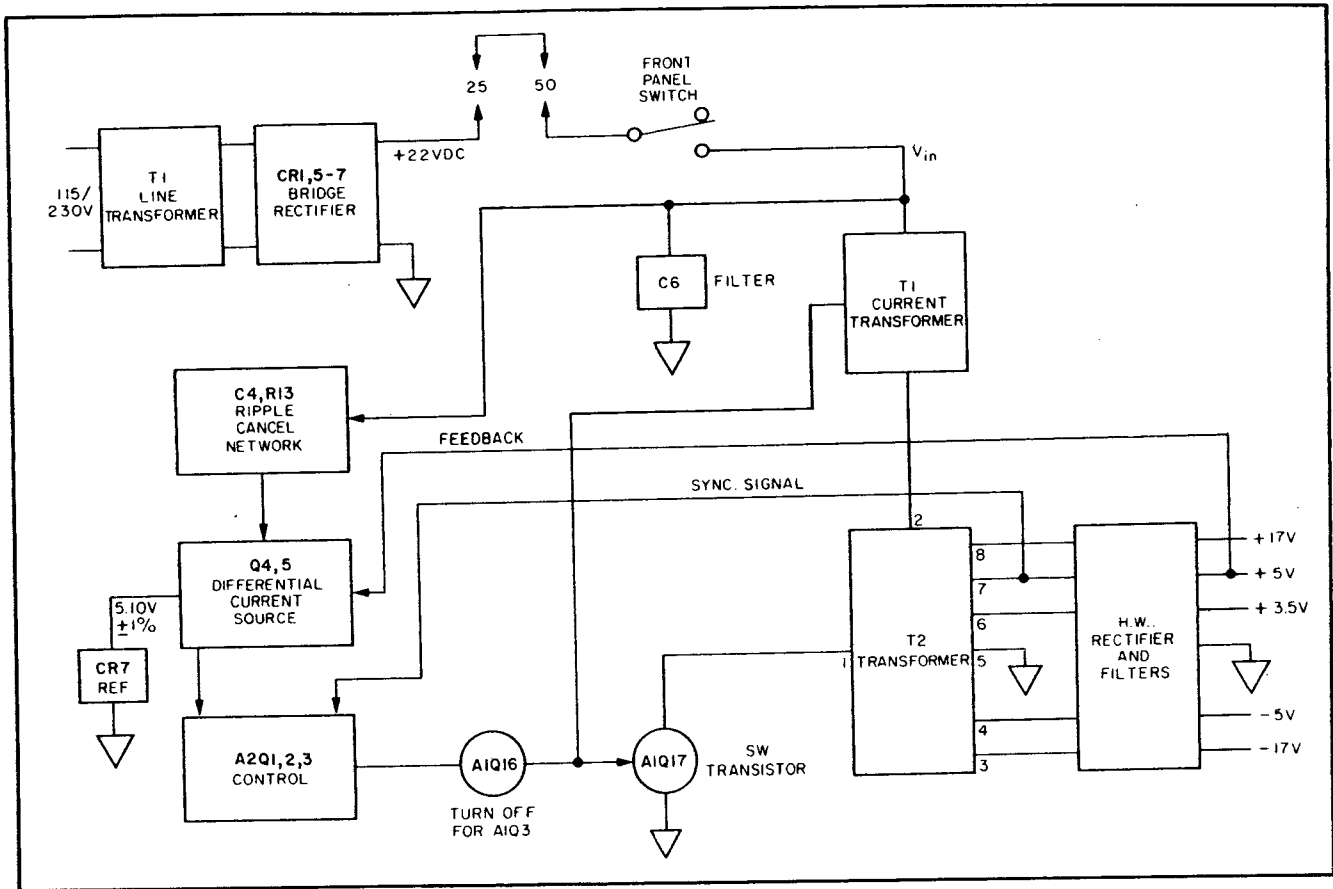

Figure 4-5. Power Supply Block Diagram

the core of A1T2 transfers into the secondaries and current flows through each of the rectifiers, A1CR2, 3, 4, 11, and 12, until the magnetic flux in the core of A1T2 is zero. This defines the end of time T2. Time T1 is the time A1Q17 is turned on and time T2 is the time A1Q17 is turned off. During time T1, energy builds up in the core of transformer A1T2. Time T2 is determined by the amount of time it takes the flux in transformer A1T2 to reach zero and is a function of the transformer and load only.

4-43. Time T1 is varied by the regulating circuit to provide the proper amount of energy storage so that secondary voltages are regulated at their proper value. The secondary voltages are all held in fixed ratios with respect to one another and are determined by the turns ratios of the secondary windings. The +5V is compared to a reference voltage on regulator board A2 and regulated to +5V ±.1 volts. This regulates the other voltages to their correct values. The -15V bias for the MOS circuits is provided by resistor A1R34 and zener diode A1CR8. Diodes A2CR5, 6, 7, and 8 provide overvoltage protection for the +5-volt, -5-volt, +17-volt, and -17-volt lines, respectively.

4-44. The regulation circuit must generate time T1 to properly regulate output voltages, and it must sense the end of time T2 so that a new cycle may be initiated.

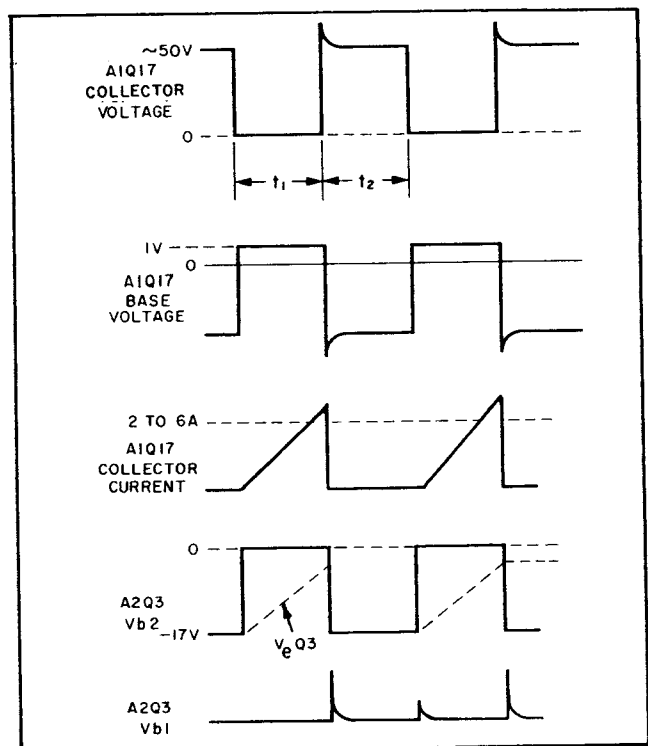

Figure 4-6. Power Supply Waveforms



4-45. A2CR4 generates the reference voltage which is compared with the +5V supply. The comparison takes place in the differential current source A2Q4 and A2Q5. Resistors A2R12, A2R8, and capacitor A2C5 provide a frequency-selective compensation network to ensure fast regulator response and prevent oscillation of the feedback loop. Resistor A2R7 biases zener diode A2CR4 from the +17V supply, and A2R5 supplies a relatively constant current to the differential pair, A2Q4 and A2Q5. Resistor A2R11 helps keep the output voltages constant as the input voltage varies over a wide range. A2C4 and A2R13 provide instantaneous voltage compensation to minimize 120 Hz ripple on the regulated output voltages.

4-46. The collector of A2Q4 supplies a current to uni-junction transistor A2Q3 and capacitor A2C2. This current varies depending on the difference between the regulated +5V and the reference voltage from A2CR4.

4-47. A2Q1 is a series-gating transistor for uni-junction transistor A2Q3. Its base is driven through resistor A2R4 which goes to the secondary of transformer A1T2. Diode A2CR1 protects the base-emitter junction of A2Q1 from excessive reverse bias. The phasing of the signal from transformer A1T2 to A2Q1 is such that UJT A2Q3 has a voltage from B1 to B2 during the time A1Q17 is turned on (Time T1).

4-48. During time T2, A2C2 cannot charge, since current flows through the diode junction of A2Q3 from the emitter to base 1. During time T1, A2C2 starts to charge at a rate determined by the current from the collector of A2Q4. If the regulated +5V is high, A2Q4 collector current is also high. This causes the charging rate of A2C2 to be relatively high. When the voltage across A2C2 reaches about 12V, A2Q3 fires and generates a 6V, 1-microsecond pulse at base 1 of A2Q3 to terminate time T1. The greater the +5V is, relative to the reference, the faster A2C2 charges and the sooner this pulse occurs. This shortens time T1 which serves to reduce the output voltages and, thus, regulation is achieved. This pulse is coupled through capacitor A2C1 and diode A2CR2 to the base of A2Q2. This turns A2Q2 on and turns A1Q16 on, pulling the A1Q16 collector low. This negative excursion is coupled through capacitor A1C29 which turns the switching transistor Q17 off and ends time T1. As A1Q17 turns off, all secondary voltages of A1T2 reverse. The voltage at A2R2 is in such a direction that A2Q2 is turned on through A2R2, after the initial pulse that was coupled through A2CR2. It is necessary to keep A2Q2 and A1Q16 conducting during the entire period of time T2.

4-49. At the end of time T2, when the flux in the core of transformer A1T2 is zero, the secondary voltages automatically reverse. This voltage again is coupled through A2R2 and turns A2Q2 off, which allows A1Q17 to turn on again, continuing the cycle. Diode A2CR3 prevents excessive reverse bias across the base-emitter junction of A1Q17. To ensure that A2Q3 is definitely off, A2C3 couples a negative spike to its emitter at the beginning of time T1.

#### 4-50. A1J1 CONNECTOR

4-51. Inputs to the measuring system mainframe and programming of its functions are provided from the plug-on module through a 50-pin connector (A1J1) in the center of the instrument. The connector signals are as listed in Table 4-5.

#### 4-52. 5310A BATTERY PACK

4-53. The 5310A Battery Pack is an accessory for the 5300 Measuring System. It connects between the 5300 Measuring System mainframe and any of the 5300 series plug-ons. The batteries are sealed Nickel Cadmium type which provide about 48-watt hours capacity with a normal output voltage of 12 volts. When the battery pack is locked between the two halves of the system, all connections are made to charge the batteries or supply power to the instrument.

4-54. Typically, a battery use-time greater than four hours-per-charge can be expected, depending on the particular plug-on used. Recharge time for completely discharged batteries is 18 hours. However, to achieve full charge in this time the batteries must be recharged with the mainframe power switch set to PWR OFF. The 5300 mainframe must be plugged into an ac source and the battery pack switch set to CHARGE.

4-55. A light-emitting diode on the battery pack front-panel glows when batteries are nearing the end of discharge.

4-56. When the batteries are fully charged they should not be left charging while operating the mainframe. For optimum long-term battery life the instrument should not be used for more than 10 minutes after the LOW BATTERY lamp begins to glow.

4-57. The three-position slide switch on the front panel has the following functions:

- a. BATTERY. The instrument gets its power from the internal batteries whether the ac line cord is plugged in or not.
- b. CHARGE. The batteries are being charged when the line cord is plugged in.
- c. LINE. The batteries are charged at a trickle-charge rate. This is the normal position when the batteries are fully charged.

4-58. In either the LINE or CHARGE position, with the line cord plugged in, a power failure switches operation to the battery pack automatically. Battery life will be approximately 10% shorter than it would be if the front-panel switch were in BATTERY position. The three positions of the front-panel switch are used as follows:

- a. BATTERY. When instrument is used away from ac line power.

Table 4-5. A1J1 Signals

PIN NO.	SIGNAL NAME	DESCRIPTION
1	+5 V	Circuit operating voltages
2	-5 V	
3	-17 V	
4	GROUND	Ground
5	F1	Signal to be accumulated in the counter after gating by the control circuit.
6	"9"	Goes low when the counter reaches 9% full scale.
7	F2	Input signal to the time base gated by the control circuit.
8	<u>INHIBIT</u>	High during the measurement cycle, low during the display cycle.
9	<u>OPEN</u>	Low signal forces the main gate flip-flop to the open position.
10	<u>CLOSE</u>	Low signal forces the main gate flip-flop to the closed position.
11	<u>LOG</u>	Logarithmic output pulse train from time base triggers main gate flip-flop on rising edge.
12	<u>MGFF</u>	Main gate flip-flop signal is low when gate is open.
13	<u>EXPONENT</u>	Inverted log pulses while main gate is open indicates number of auto-ranging steps.
14	NO CONNECTION	
15	RESET	High signal resets all registers.
16	CLOCK	10 MHz reference signal from crystal oscillator.
17	<u>MAX TIME</u>	Low signal enables closing of the gate on next log pulse. Rising edge initiates display cycle.
18	TIME BASE OUTPUT	Output from the time base decade position selected by the time base select code on pins 22, 23, and 24.
19	<u>PRINT</u>	Low signal provides print command to rear panel connector.
20	<u>TRANSFER</u>	Low signal transfers data to display. High signal stores data.
21	1 MHz TIME BASE INPUT	Input direct from plug-on bypasses control circuit.
22	TIME BASE SELECT A	Time base select code A, B, and C selects the time base division factor of the signal at the time base output at pin 18.
23	TIME BASE SELECT B	
24	TIME BASE SELECT C	
25	+22 V	Full wave rectified voltage from the power transformer secondary. Provides power to charge the battery pack. If no battery pack is used, pin 25 is connected via the plug-on to pin 50 (DC-IN).
26	+17 V	Pins 27 through 31 provide the drive to the annunciator lights on the front panel. A low signal lights the corresponding indicator.
27	<u>Hz</u>	
28	<u>M</u>	
29	<u>S</u>	
30	<u>K</u>	
31	<u>μ</u>	
32	<u>MANUAL RESET</u>	Low signal from front panel pushbutton switch on rear panel input clears the system to zero.
33	<u>DP1</u>	Low signal activates decimal point 1.

Table 4-5. A1J1 Signals (Continued)

PIN NO.	SIGNAL NAME	DESCRIPTION
34	$\overline{DP2}$	Low signal activates decimal point 2.
35	RIGHT/LEFT	Code indicating half character which is being addressed. High when right-hand of character is displayed.
36	DIGIT ADDRESS X	Digit address code X, Y, Z from the display scanner indicates a digit being displayed.
37	DIGIT SELECT X	
38	DIGIT ADDRESS Y	
39	DIGIT SELECT Y	
40	DIGIT ADDRESS Z	
41	DIGIT SELECT Z	
42	DATA "D"	The data code A, B, C, D represents the digit to be displayed in binary coded decimal form. Data lines can carry the counter output information to the plug-on as well as to the display or can bypass the counter and bring plug-on data to the display.
43	DATA "C"	
44	DATA "B"	
45	DATA "A"	
46	$\overline{DP3}$	Low signal activates decimal point 3.
47	$\overline{DP4}$	Low signal activates decimal point 4.
48	$\overline{DP5}$	Low signal activates decimal point 5.
49	GROUND	Ground
50	DC IN	DC power to power supply from battery pack or from 22 volt input power from pin 25.

b. CHARGE. When instrument batteries are to be charged, regardless of whether the mainframe is used or not.

c. LINE. For normal operation from the ac power line.

4-59. The 5310A circuitry can be divided into two parts.

a. The current regulator for charging the battery.

b. The circuit to indicate when the battery voltage is low.

4-60. Transistors A2Q1, A2Q2, and A2Q3 in combination with A2R2, A2R1 perform the function of a current regulator. Unregulated voltage from the 5300 mainframe, which is present whenever the line cord is plugged in, is applied to TOP connector A1P1(25). In the CHARGE position this voltage is applied to the current regulator. Normal voltage is about +22 volts; the battery voltage in CHARGE position is typically +14 volts. The current regulator supplies a constant current of about .3 Ampere, independent of line voltage to the batteries when the switch is in CHARGE position. A2R2 is the current sample resistor. A2CR1 prevents base-to-emitter breakdown of A1Q1 due to current flowing out of the battery backwards through A1Q1, when the line power is turned off.

4-61. A trickle-current of about 10 milliamperes is supplied to the battery through A2R4 when the front-

panel switch is set to LINE. Diodes A2CR4, A2CR3, and light-emitting diode DS1, with resistors A2R3, A2R5 and transistor A2Q4, indicate when battery voltage is getting low and nearing the end of discharge. A regulated +5.0 volts from the mainframe is supplied to the emitter of A2Q4. Battery voltage is sent, through A2CR2 and A2CR3, to A2Q4 base. When battery voltage becomes low, A2Q4 turns on through A2R3 and A2CR3. Diode A2CR3 protects A2Q4 from base-to-emitter reverse breakdown when the battery voltage is high.

4-62. When the battery voltage drops below 11½ to 12 volts, A2Q4 turns on. This completes a path for the +5 volts from the mainframe, through A2R5, and the light-emitting diode glows. Normally, this occurs for a few minutes at the beginning of a charge cycle. Fuse F1 is in series with the battery to prevent damage from accidental shorts. A2CR4 allows current to flow from the battery into the mainframe if line power fails. A2C2 is in parallel with the filter capacitor on the unregulated 22V line from the 5300 mainframe. It provides additional filtering for the additional current drawn by the batteries when the battery pack is being used. For longest life it is recommended that the batteries not be continuously overcharged for long periods. Discharging far past the time when the front-panel LOW BATTERY light comes on is also undesirable.

## SECTION V MAINTENANCE

### 5-1. INTRODUCTION

5-2. This section contains maintenance and service information for Model 5300B Measuring System. Included are adjustment procedures, tests, troubleshooting tables and diagrams to localize, isolate, and locate defective components. Performance check procedures are not included, since a plug-on must be used. These procedures are included with the respective plug-on.

### 5-3. RECOMMENDED TEST EQUIPMENT

5-4. Test equipment recommended for maintaining, troubleshooting, and servicing the 5300B Measuring System is listed in Table 5-1. Test equipment with equivalent characteristics may be substituted for equipment listed.

### 5-5. INSTRUMENT ACCESS

5-6. For access to mainframe assembly, separate the 5300B from plug-on used as follows:

- a. Turn ac power OFF and disconnect power cord.
- b. Pull the two side casting latches fully rearward (it is necessary to press the latch handles gently away from the center of the instrument to unlock them).
- c. When latches are fully extended rearward, the 5300B and plug-on castings should be separated by about 1/8-inch.
- d. Lift the 5300B gently away from the plug-on.

Table 5-1. Recommended Test Equipment

EQUIPMENT TYPE	CHARACTERISTICS	RECOMMENDED INSTRUMENT
Oscilloscope	50 MHz Band Width 5 mV cm	HP 180A/HP 1801A/HP 1820A
Test Oscillator	Range: 10 Hz to 10 MHz Output: 5V p-p into 50-Ohm	HP 651B
Feed-thru Termination	50-Ohm male to femal BNC connectors	HP 11048B
Pulse Generator	Repetition Rate: 10 Hz to 10 MHz Peak Voltage: 10V into 50-Ohn Pulse Width: 30 nsec to 5 msec Pulse Polarity: + or -	HP 222A
Integrated Circuit Logic State Display	Displays Logic State of 14 & 16 pin Integrated Circuit	HP 10528A
Logic Probe	Indicate logic levels	HP 10525T
Electronic Counter	.1 Hz to 10 MHz frequency measurements	HP 5245L/M or 5345A
DC Voltmeter	0 to 200 Vdc, 1% accuracy	HP 412A, 5306A
DC Power Supply	0 to 20V at 1.5 AMP	HP 6200B
50-pin Female Connector	50-pin Female blue-ribbon connector	HP Part Number 1251-0101 (CINCH 57-20500-375)
<b>HP Model 10548A Diagnostic Service Kit consisting of:</b>		
Shorting Plug	Implements codes on Diagnostic Cards	HP 5080-0058, 2 ea.
Diagnostic Interface Connector	Interface between 50-pin connector and 44-pin connector.	HP 05300-60004, 1 ea.
Diagnostic Card "A"	Provides fixed tests to check 5300 circuits, including the display.	HP 05300-20011
Diagnostic Card "B"		HP 05300-20012
Diagnostic Card "C"		HP 05300-20013
Diagnostic Card "D"		HP 05300-20014
		} 1 ea.

e. Separate 5300B Logic Board Assembly from 5300B casting as follows:

1. Remove retaining screw located near power transformer.
2. Press rear, plastic-nylon retaining clips on each side of the 5300B casting and lift the rear of the Logic Board Assembly to release it from the casting.
3. Press front plastic-nylon retaining clips on each side of 5300B casting and lift the front of the Logic Board Assembly to release it from the casting.

f. Mate the 5300B Logic Board Assembly to the plug-on used and reapply ac power.

### 5-7. PERIODIC MAINTENANCE

5-8. To determine if the 5300B is operating within specifications, perform the In-Cabinet Performance Checks listed in the documentation for the specific plug-on used and the troubleshooting methods and procedures listed in Paragraph 5-13.

### 5-9. MAINTENANCE AND REPAIR

#### CAUTION

A1U1, A1U2 are large-scale MOS integrated circuits whose inputs are susceptible to damage from high voltage and static charges. Particular care should be taken to avoid excessive capacitive loading with probes or when handling under conditions where static charges can build up.

5-10. BOARD REMOVAL. When removing the printed circuit board for replacement, repair, or servicing, always remove ac power and separate the board from the casting using steps a to e of Paragraph 5-6.

5-11. COMPONENT REPLACEMENT. When replacing a circuit board component use a low heat soldering iron. Heat must be used sparingly as damage to the circuit foil may result. Mounting holes may be cleaned out with a toothpick while heat is applied. Connection should be cleaned with a cleaning solution after component removal and replacement.

5-12. INTEGRATED CIRCUIT REPLACEMENT. Two methods are recommended for removing integrated circuits.

a. Solder Gobbler. Solder is removed from board by a soldering iron with a hollow tip connected to a vacuum source. The IC is removed intact so it may be reinstalled if diagnosis is wrong.

b. Clip Out. This method is used when an IC is proven defective. Clip leads close to case, apply heat and remove leads with long nose pliers. Clean board holes with toothpick and cleaning solution.

### 5-13. INSTRUMENT TROUBLESHOOTING

5-14. GENERAL. Trouble isolation can best be accomplished by first obtaining all possible information from controls, connectors, and indicators, then logically using this information to locate the defective component.

5-15. MODULE SUBSTITUTION. Maintenance procedures in the 5300B may be simplified by isolating the problem to one or a group of the Integrated Circuits and replacing the suspected bad IC's with known good spares. A recommended selection of spare IC's is noted in the parts list of Section VI.

5-16. TROUBLESHOOTING. Three methods of troubleshooting are available. These are:

a. 5300B mated to the plug-on in use. Tests located in Paragraph 5-20 and Figure 5-1 and 5-2 can be performed with plug-on mated to the mainframe. Additional tests can be performed with a plug-on, using performance and maintenance checks in the plug-on section.

b. Diagnostic Test Cards. Test Cards 05300-20011, 20012, 20013, and 20014, and Diagnostic Interface card 05300-60004 are factory available cards which have fixed programs used in exercising the 5300B circuits. This is the preferred and recommended method. This method enables the user to troubleshoot the 5300B without a plug-on.

#### NOTE

Tests performed with the "Test Cards" can be related to tests on Pages 5-4 to 5-10. If a failure occurs when using the "test cards," use the description listed on Pages 5-4 to 5-10 in conjunction with the "test cards" to determine which program lines are faulty.

**CAUTION**

Disconnect power cable if display is dim or power supply is noisy (loud whine).

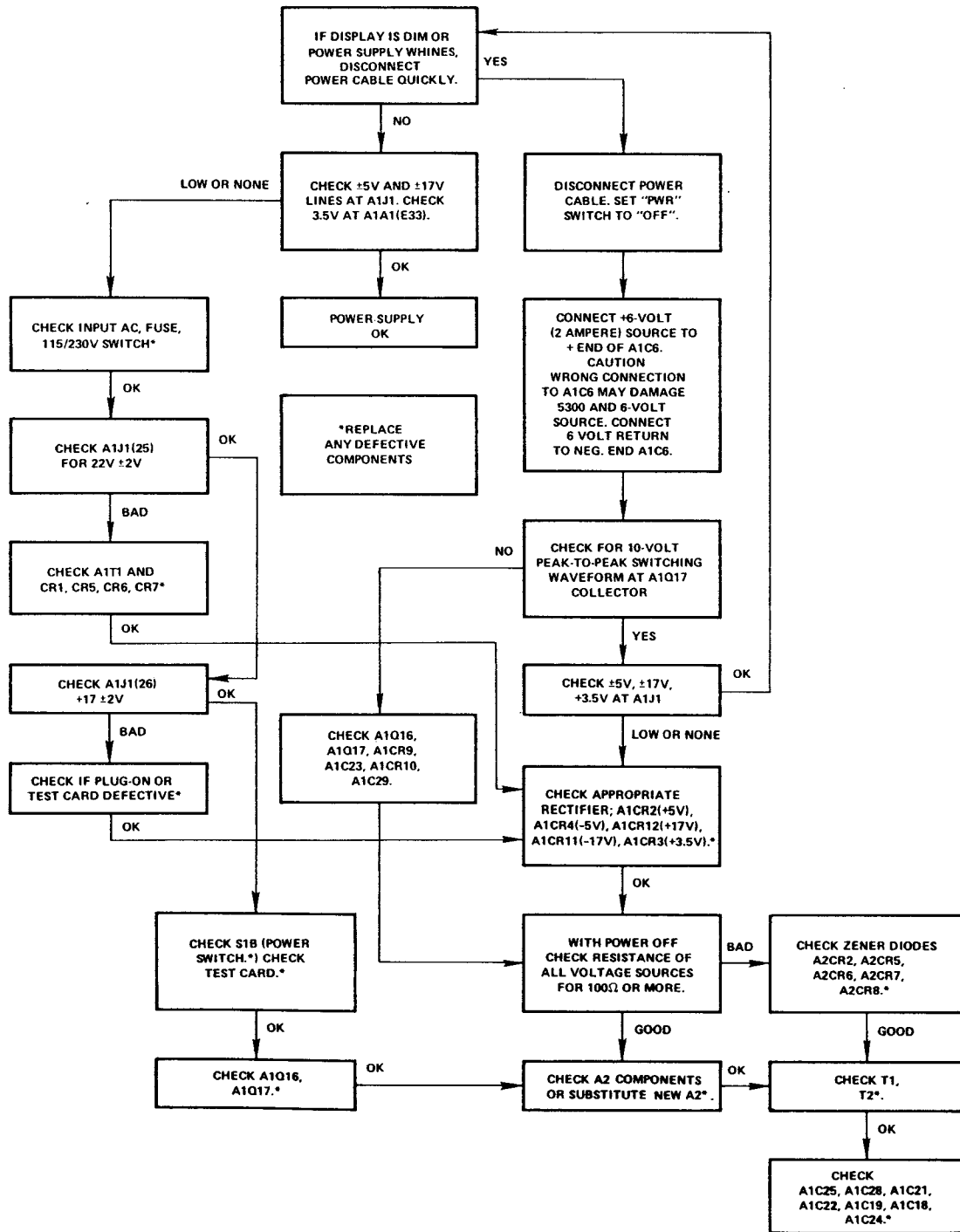

Figure 5-1. 5300B Power Supply Checks

c. Alternate Method. This is the second preferred method. The user can hard wire certain connections on the 5300B 50-pin connector and can troubleshoot the 5300B without having a plug-on connected. Refer to paragraph 5-48.

5-17. The following paragraphs and tables are procedures and tests designed to exercise the various circuits in the 5300B mainframe and to logically isolate the defective component(s) or assembly. The tests are also designed to be performed using a 5300B mainframe by itself. Equipment required for these tests is listed in Table 5-1.

5-18. Subsequent tests are made using Diagnostic Test Cards A through D. These cards are mated to a Diagnostic Interface extender card. When a malfunction is suspected or failure occurs, separate the 5300B mainframe from the plug-on, and remove the casting as instructed in Paragraph 5-5.

5-19. Power Supply Checks. Power Supply voltages may be checked by connecting pins 50 and 25 together. The preferred method, however, is to use the Diagnostic Interface Card, and Diagnostic Test Card "B," Test 7. Perform Power Supply Checks and oscilloscope checks using Figure 5-1 troubleshooting chart as an aid. Voltages should be:

- +5.2 Vdc  $\pm$ .25V at A1J1(1)
- 5 Vdc  $\pm$ .25V at A1J1(2)
- 17.5 Vdc  $\pm$ 1.7V at A1J1(3)
- +17.5 Vdc  $\pm$ 1.7V at A1J1(26)
- +24 Vdc  $\pm$ 2V at A1J1(25, 50)

5-20. DIAGNOSTIC TEST CARDS. Diagnostic Test Card "A," tests 1 through 4, check out the display circuitry. Circuits tested are:

a. U7 and U8 circuits; the LED display anode drivers Q2 through Q8; digit address lines X, Y, Z, DP (decimal point) line; and R/L (right-left) control lines.

b. U14 BCD-to-seven segment decoder and cathodes of LED display.

5-21. Diagnostic Test Card "B" tests 5, 6, and 7 check out the majority of inputs and outputs to U1, U2, and U5 for the various modes of operation that can be performed with a plug-on. Test number 8 checks out the Annunciators and Decimal Point lines of the Display Assembly.

5-22. Diagnostic Test Card "C" tests 9 through 12 and Diagnostic Test Card "D" tests 13 through 16 check out the MOS Time Base Circuitry and the MOS Decade Counter. By varying the input and outputs on U1 and U2 with a fixed program, the special circuits are exercised.

### 5-23. Diagnostic Test Card "A"

5-24. To use the Diagnostic Test Card "A," connect this card through the Interface Card, HP Part No. 05300-60004, to 5300 A1J1 mainframe connector. Prior to each test, press RESET and refer to Figure 5-2. Insert side of card marked "Test 1."

5-25. Test 2. Tests the remaining numerical digits. Display should read 987610 only. If display is 107610, check DATA D line for a low level. Replace U1 to repair.

5-26. Test 3. Tests the remaining character codes. Display should read  $\blacksquare \square - \square \blacksquare \blacksquare \square$ . Refer to Figure 5-3.

5-27. Test 4. Tests U14, U1, F1 input to U9, and A1A1DS1-8 to display 8 digits simultaneously and to cycle them 8 at a time) from 0 to 9. Refer to Figure 5-4, Test 4, "C" lamp is on all the time.

### 5-28. Diagnostic Test Card "B"

5-29. To use Diagnostic Test Card "B," connect this card through the interface card, HP Part No. 05300-60004, to 5300B mainframe A1J1 connector. Prior to each test, press RESET.

5-30. Test 5 and press "PUSH TO RESET" knob. Checks U1, U2, U9. Display should be  $\odot \text{88888888} (\odot$  = overflow). "C" lamp and overflow should cycle once.

5-31. Test 6. Checks U3, U4, U5. Refer to Figure 5-5. Display should read at turn on 0000007, 1 second later 0000008, and about 10 seconds later 0000009.

5-32. Test 7. Checks U1, U2, U9. Refer to Figure 5-6. Turn sample rate  $\frac{1}{2}$  cw. Display should be 010.0000 MHz  $\pm$ 1 count. "C" lamp cycling.

5-33. Test 8. Checks Annunciators and Decimal Points 1 through 5. Display should be 76543210 "C" lamp cycling. See Figure 5-6.

5-34. Use a shorting plug (HP Part No. 5080-0058) to connect points on test card B, Test 8, to check the Annunciators (Hz, M, S, K,  $\mu$ ) and decimal points 1 through 5. To light a particular annunciator or decimal point, plug shorting bar into the corresponding holes for that annunciator or decimal point. The "C" lamp off.

### 5-35. Diagnostic Test Card "C"

5-36. Tests 9-12. To use Diagnostic Test Card "C," connect this card through the interface card, HP Part No. 05300-60004, to 5300B mainframe A1J1 connector. Prior to each test, press RESET.

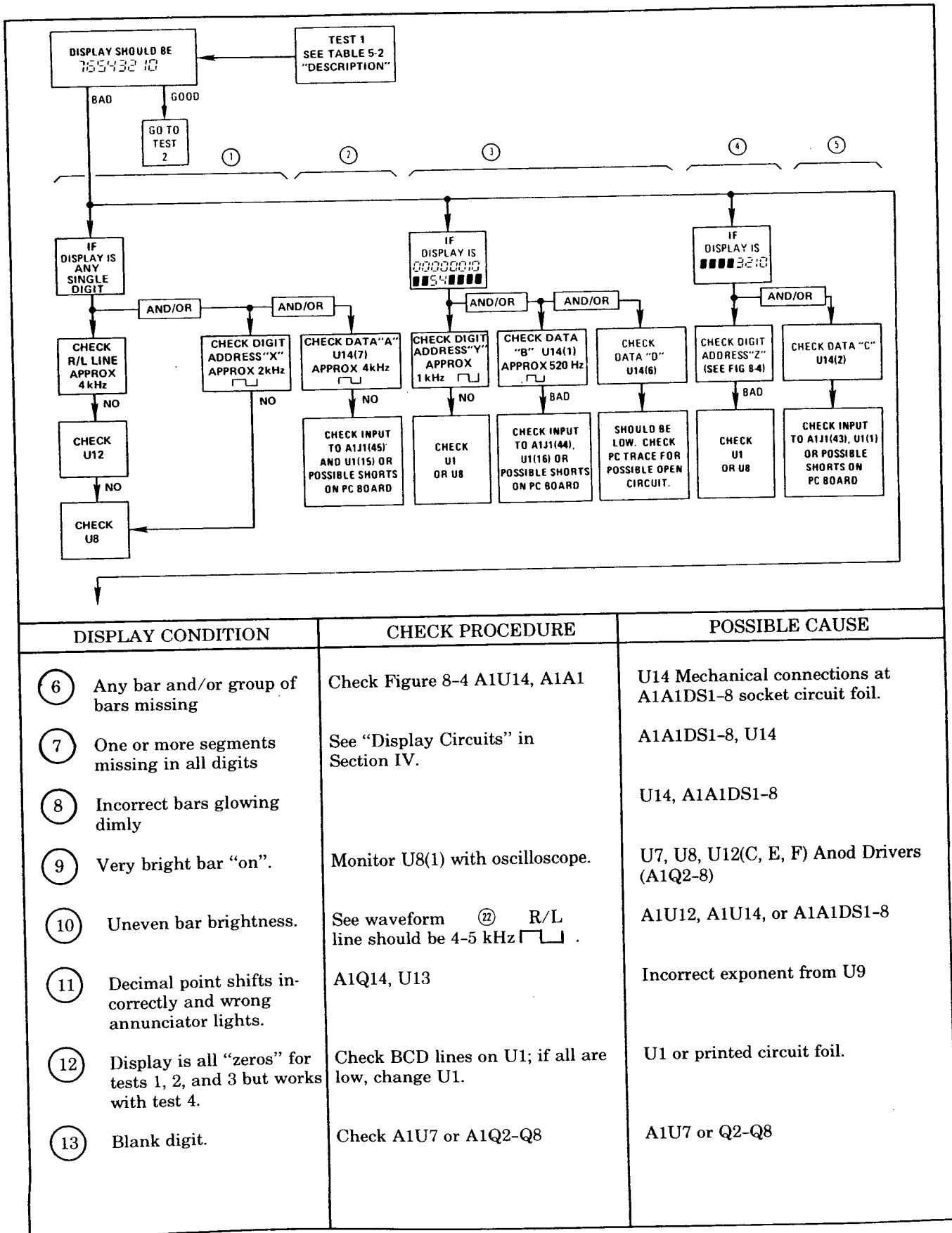

Figure 5-2. Display Checks



**TEST CARD A, TEST 1 LOGIC LEVELS**

The patterns below labelled with A1 integrated circuit numbers show the correct logic levels for those integrated circuits with diagnostic test card A and test 1. Either an HP Model 10528A Logic Clip or a Model 10525T Logic Probe can be used to check for these patterns. Dark pattern indicates a logic high. If different levels are detected it indicates where further troubleshooting should be started.

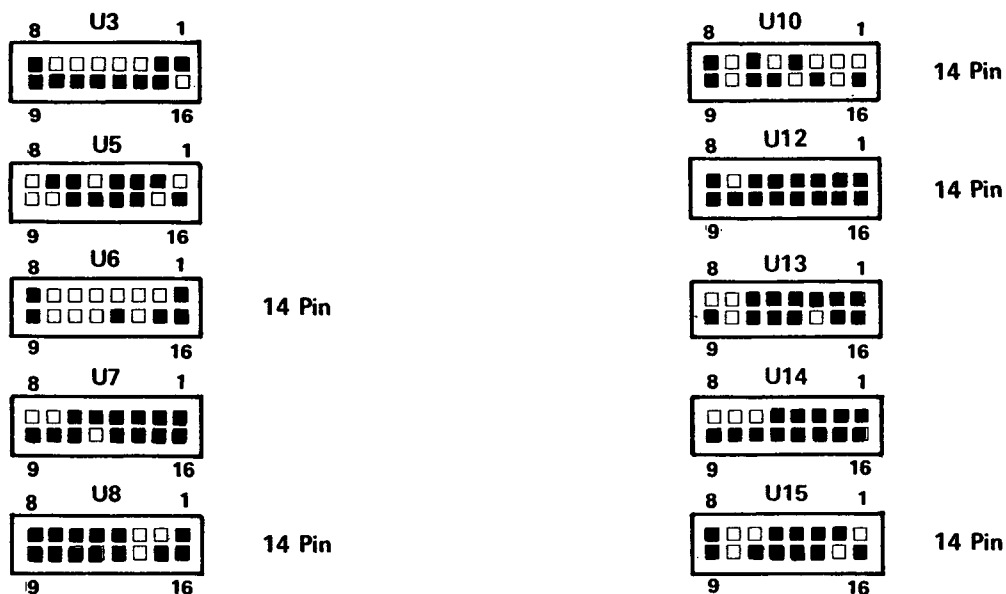

Figure 5-2. Display Checks (Continued)

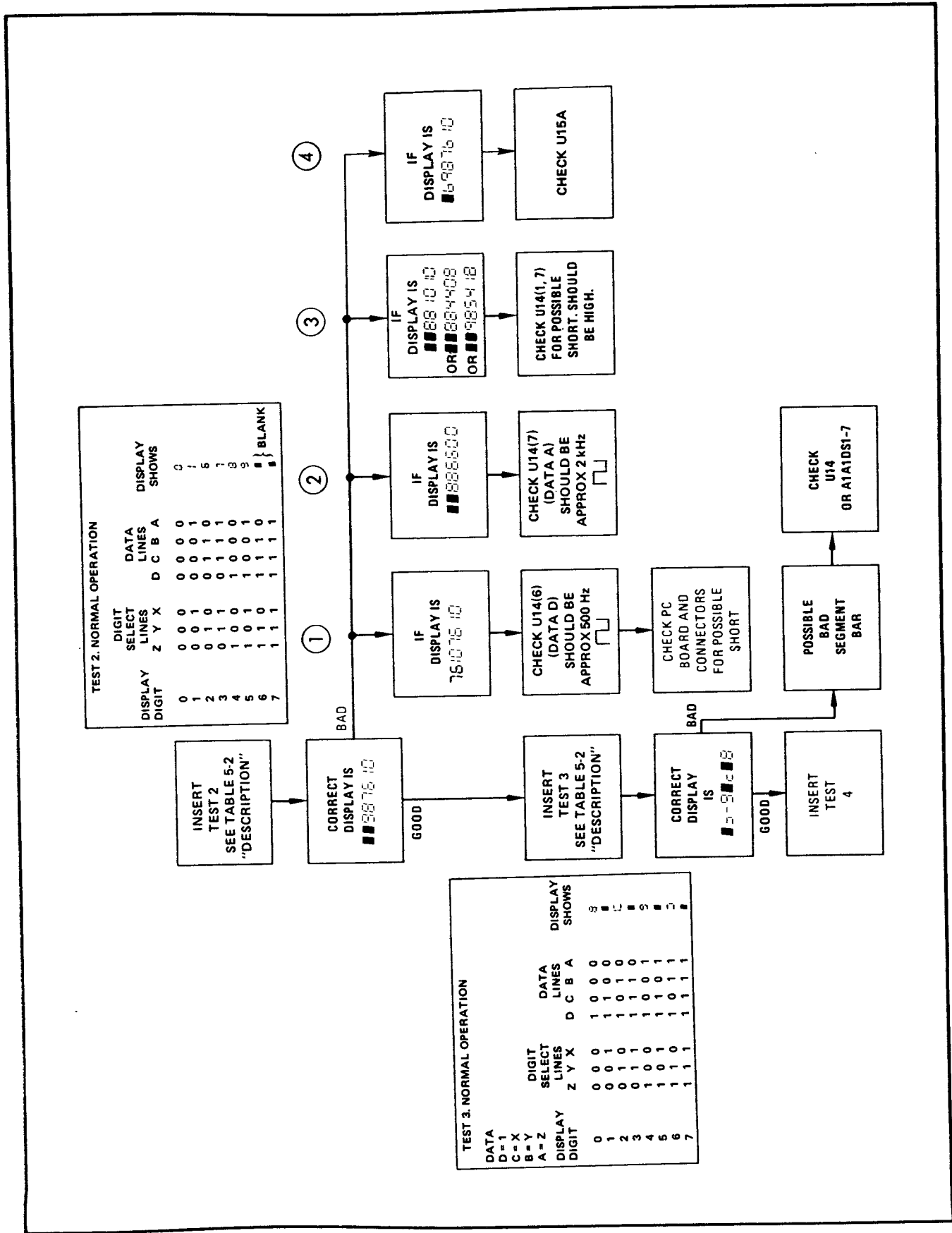

Figure 5-3. Display Checks

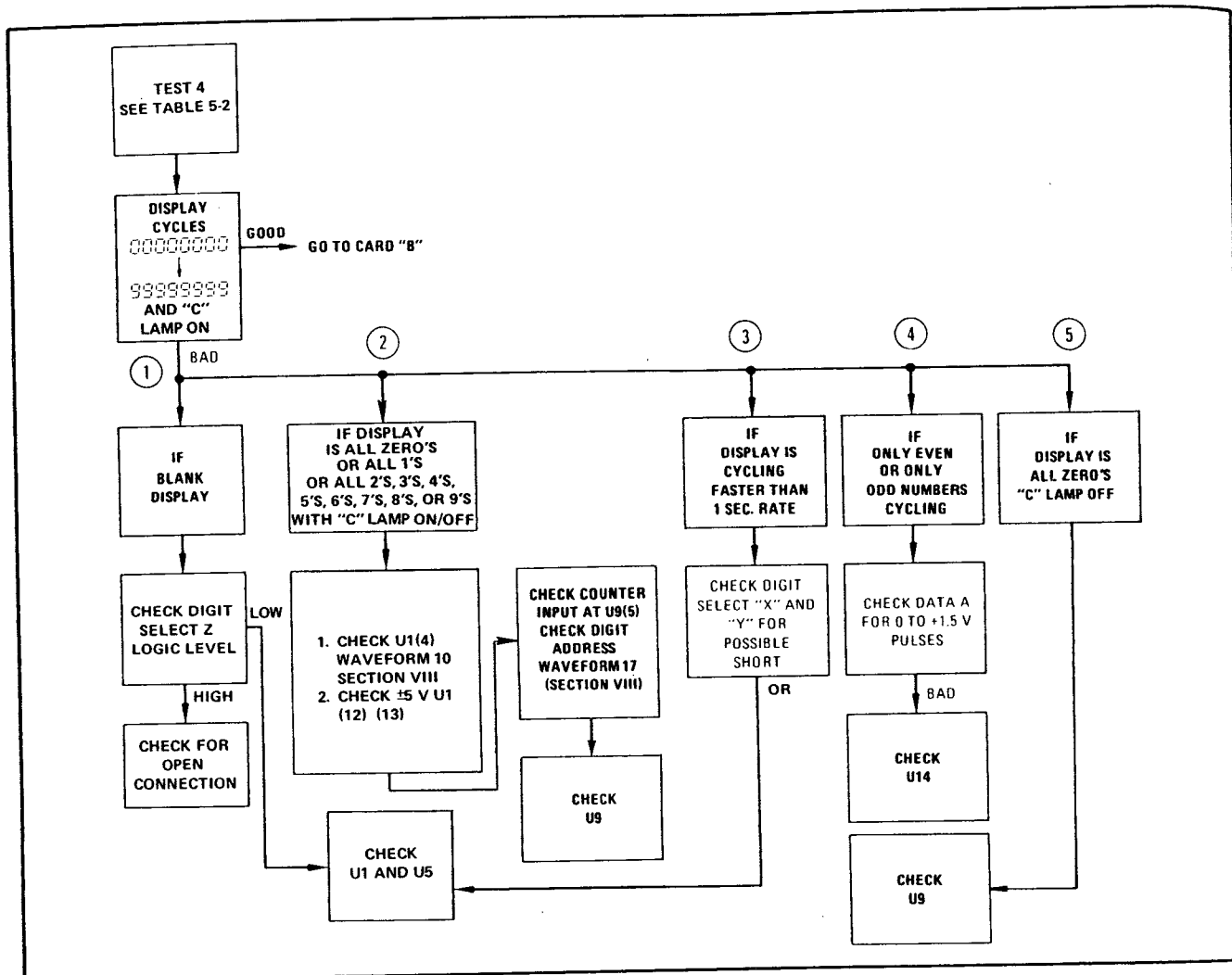

Figure 5-4. Display Checks

5-37. These tests check U1 and U2 by programming the Time Base input codes to provide Time Base output signals in decade steps.

5-38. Test 9. Fixed program tests the 10-second Time Base output. Display should accumulate one count every 10 seconds starting with digit 0, least-significant digit. "C" lamp on.

5-39. Test 10. Fixed program tests the 1-second Time Base output. Display should accumulate one count every second starting with digit 0, least-significant digit. "C" lamp on.

5-40. Test 11. Fixed program tests the .1-second Time Base output. Display should accumulate one count every second in digit 1 (second from the right). "C" lamp on.

5-41. Test 12. Fixed program tests the 10 msec Time Base output. Display should accumulate one count

every second in digit 2 (third from the right). "C" lamp on.

#### 5-42. Diagnostic Test Card "D"

5-43. Tests 13-16. To use Diagnostic Test Card "D," connect the card through the interface card, HP Part No. 05300-60004, to 5300B mainframe A1J1 connector. Prior to each test, press RESET. These tests check U1 and U2 by programming the time base input codes to provide Time Base output signals in decade steps.

5-44. Test 13. Fixed program tests the 1 msec Time Base output. Display should accumulate one count every second in digit 3 (fourth from the right). "C" lamp on.

5-45. Test 14. Fixed program tests the .1 msec Time Base output. Display should accumulate one count every second in digit 4 (fifth from the right). "C" lamp on. (Overflow lamp should be on after 1000 seconds.)

### TEST CARD A, TEST 4 LOGIC LEVELS

The patterns below labelled with A1 integrated circuit numbers show the correct logic levels for those integrated circuits with diagnostic test card A and test 4. Either an HP Model 10528A Logic Clip or a Model 10525T Logic Probe can be used to check for these patterns. A dark pattern indicates a logic high. If different levels are detected it indicates where further troubleshooting should start.

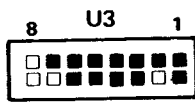

(\*) Cycle with Display (pins 3, 4, 5 and 6)  
When Manual Reset is pushed (pins 1, 2, 7 and 16) are lit; all others blank.

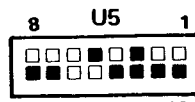

14 Pin  
When Manual Reset is pushed, pins 2, 5, 6, 10 and 14 are blank.

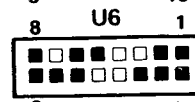

14 Pin

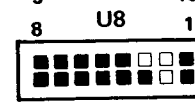
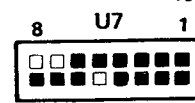

14 Pin

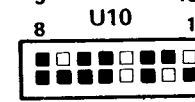

14 Pin  
When Manual Reset is pushed, 2, 5 and 10 are blank.

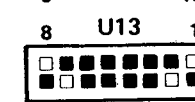
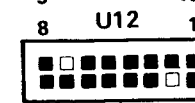

When Manual Reset is pushed, pin 1 lits and 14 blanks.

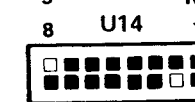

(\*) Cycle with Display (pins 1, 2, 6, 7, 9, 10, 11, 12, 13, 14).  
When Manual Reset is pushed, pins 4, 5 and 16 are lit.

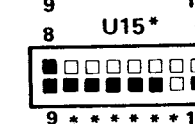

14 Pin (Pins 1-5 should be cycling)  
\*Pins 3, 15-16 stay on when Manual Reset is pushed.

Figure 5-4. Display Checks (Continued)

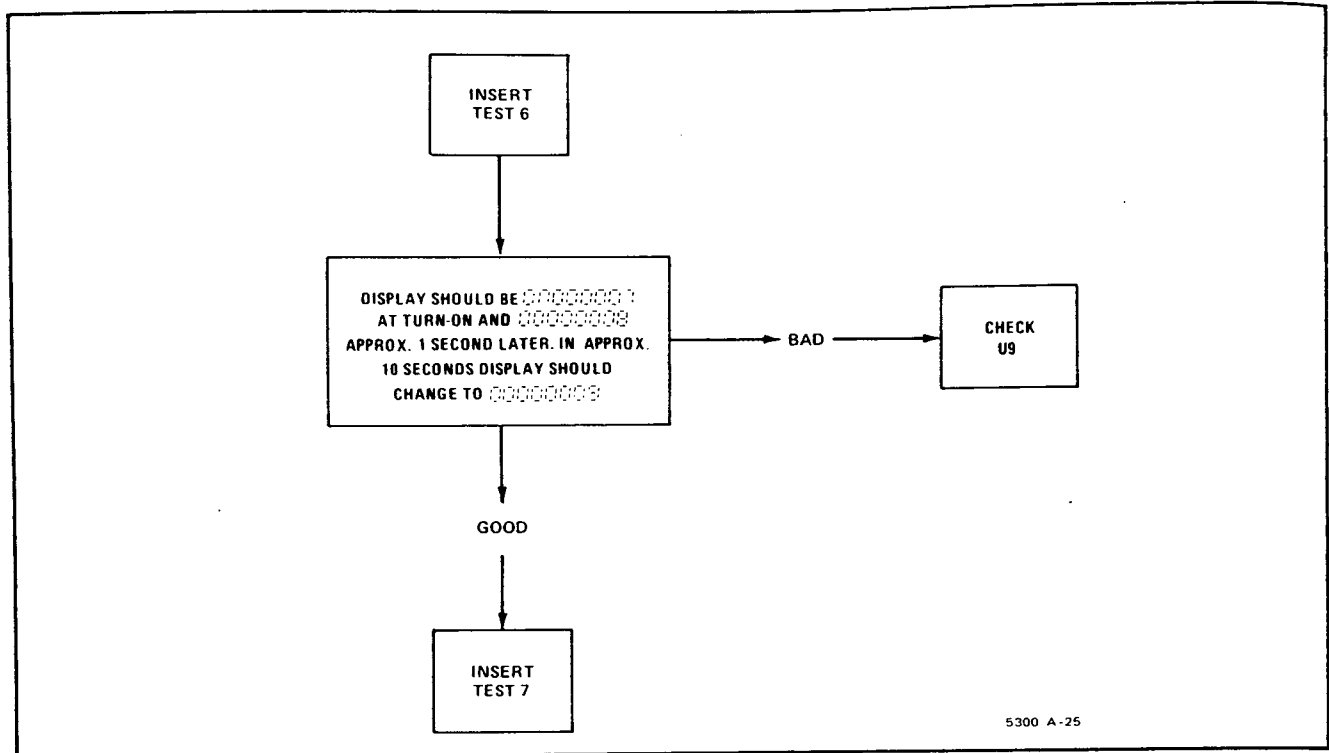

Figure 5-5. A1U1 Counter, A1U2 Time Base, and A1U9 Control Checks

5-46. Test 15. Fixed program tests the 10  $\mu$ sec Time Base output. Display should accumulate one count every second in digit 5 (sixth from the right). "C" lamp on. (\* = overflow lamp on after 100 seconds.)

5-47. Test 16. Fixed program tests the 1  $\mu$ sec Time Base output. (Overflow lamp should light and remain on after 10 seconds. "C" lamp on.) Display should accumulate one count each second in digit 6 (seventh from right).

#### 5-48. ALTERNATE METHOD OF TROUBLE ISOLATION

5-49. Obtain a female 50-pin connector, HP Part No. 1251-0101 (CINCH 57-20500-375), and hard-wire the following listed programs by soldering short pieces of wire to the selected pins.

5-50. Tables 5-2, 5-3, and 5-4 list the wired connections and correct displays.

### CAUTION

During soldering and use, do not short adjacent pins to each other or to the connector case. Damage to the 5300B may result.

#### 5-51. OSCILLATOR ADJUSTMENT

5-52. Two methods of oscillator adjustment are available:

a. Using an electronic counter to measure the 5300B 10 MHz oscillator frequency at the 5300B rear-panel OSC jack.

b. Using the oscilloscope-drift method to compare the 5300B oscillator drift against a reference or "house" standard.

#### 5-53. STANDARD OSCILLATOR DIRECT COUNT MEASUREMENT AND ADJUSTMENT

5-54. The 5300B oscillator can be measured by connecting an electronic counter, whose time base oscillator stability is at least 10 times better than the 5300B oscillator, to the 5300B rear-panel OSC jack. To measure the 5300B oscillator frequency proceed as follows:

a. Obtain an HP Model 5345A or 5245L/M Counter and connect the 5300B OSC jack to the 5245L/M input.

#### NOTE

The internal oscillator can be pulled off frequency by excessive loading at rear-panel OSC jack J2. Use no less than a 100 ohm load (200 $\Omega$  for Option 001) when measuring oscillator frequency at J2.

b. Set 5345A or 5245L/M controls for a minimum 7-digit stable display. Use "1M $\Omega$ " input to 5345A counter.

(Continued on page 5-14)





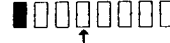
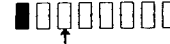

Table 5-2. Tests 1, 2, 3, and 4

TEST 1 (SAME AS DIAGNOSTIC CARD NO. A)				
Pin No.	Connected To	Pin No.	Description (Lines Connected Together)	Display Should Be
(4)	—————>	(42)	Gnd/Data "D"	<div style="border: 1px solid black; padding: 5px; display: inline-block;">76543210</div>
(36)	—————>	(45)	Digit Address "X"/Data "A"	
(38)	—————>	(44)	Digit Address "Y"/Data "B"	
(40)	—————>	(43)	Digit Address "Z"/Data "C"	
(50)	—————>	(25)	DC-IN (+22 V)	
TEST 2 (SAME AS DIAGNOSTIC CARD NO. A)				
(36)	—————>	(45)	Digit Address "X"/Data "A"	<div style="border: 1px solid black; padding: 5px; display: inline-block;">■■387610</div>
(38)	—————>	(43) (44)	Digit Address "Y"/Data "B", "C"	
(40)	—————>	(42)	Digit Address "Z"/Data "D"	
(50)	—————>	(25)	DC-IN (+22 V)	
TEST 3 (SAME AS DIAGNOSTIC CARD NO. A)				
(36)	—————>	(43)	Digit Address "X"/Data "C"	<div style="border: 1px solid black; padding: 5px; display: inline-block;">■5-9■e■8</div>
(38)	—————>	(44)	Digit Address "Y"/Data "B"	
(40)	—————>	(45)	Digit Address "Z"/Data "A"	
(50)	—————>	(25)	DC-IN (+22 V)	
TEST 4 (SAME AS DIAGNOSTIC CARD NO. A)				
(4)	—————>	(9) (41) (20), (19)	Gnd/Open, Digit Select "Z", Print and Transfer	<div style="border: 1px solid black; padding: 5px; display: inline-block;">           00000000            cycle to            99999999         </div> PUSH "RESET" <div style="border: 1px solid black; padding: 2px; display: inline-block;">88888888 e</div> (DISPLAY) (LED TEST)
(38)	—————>	(5)	Digit Address "Y"/F <sub>1</sub>	
(50)	—————>	(25)	DC-IN (+22 V)	

Table 5-3. Tests 6, 7, and 8

TEST 6 (SAME AS DIAGNOSTIC CARD NO. B)																																	
Pin No.	Connected To	Pin No. Description (Lines Connected Together)	Display Should Be																														
(4)	→	(9) Gnd/Open, Print and Transfer, (20), (19)	At turn on: <div style="border: 1px solid black; padding: 2px; display: inline-block;">0000007</div> 1 sec after turn on: <div style="border: 1px solid black; padding: 2px; display: inline-block;">0000008</div> Adjust Sample Rate 1/2 cw 10 sec after turn on: <div style="border: 1px solid black; padding: 2px; display: inline-block;">0000009</div>																														
(5)	→	(13) F <sub>1</sub> /Exponent																															
(7)	→	(16) F <sub>2</sub> /Clock																															
(36)	→	(37) Digit Address "X"/Digit Select "X"																															
(38)	→	(39) Digit Address "Y"/Digit Select "Y"																															
(40)	→	(41) Digit Address "Z"/Digit Select "Z"																															
(50)	→	(25) DC-IN (+22 V)																															
TEST 7 SELF-CHECK (SAME AS DIAGNOSTIC CARD NO. B)																																	
(1)	→	(6) +5 V/9	<div style="border: 1px solid black; padding: 2px; display: inline-block;">0 100000 MHz</div> (+1 Count)																														
(4)	→	(27) Gnd/TBS "A", "B", Hz, M, DP4 (28) (22) (23) (47)																															
(5)	→	(7) F <sub>1</sub> /F <sub>2</sub> , Clock (16)																															
(17)	→	(18) MAXTIME/Time Base Output																															
(36)	→	(37) Digit Address "X"/Digit Select "X"																															
(38)	→	(39) Digit Address "Y"/Digit Select "Y"																															
(40)	→	(41) Digit Address "Z"/Digit Select "Z"																															
(50)	→	(25) DC-IN (+22 V)																															
TEST 8 (SAME AS DIAGNOSTIC CARD NO. B)																																	
(4)	→	(42) Gnd/Data "D"	<div style="border: 1px solid black; padding: 2px; display: inline-block;">765432 10</div>																														
(36)	→	(45) Digit Address "X"/Data "A"																															
a. (38)	→	(44) Digit Address "Y"/Data "B"																															
(40)	→	(43) Digit Address "Z"/Data "C"																															
(50)	→	(25) DC-IN (+22 V)																															
(4)	→	(27) Gnd (4) Pins on Card <table style="display: inline-table; vertical-align: middle;"> <tr><td>○</td><td>→</td><td>Hz</td></tr> <tr><td>○</td><td>○</td><td>M</td></tr> <tr><td>○</td><td>○</td><td>S</td></tr> <tr><td>○</td><td>○</td><td>K</td></tr> <tr><td>○</td><td>○</td><td>μ</td></tr> <tr><td>○</td><td>○</td><td>DP1</td></tr> <tr><td>○</td><td>○</td><td>DP2</td></tr> <tr><td>○</td><td>○</td><td>DP3</td></tr> <tr><td>○</td><td>○</td><td>DP4</td></tr> <tr><td>○</td><td>○</td><td>DP5</td></tr> </table>	○	→	Hz	○	○	M	○	○	S	○	○	K	○	○	μ	○	○	DP1	○	○	DP2	○	○	DP3	○	○	DP4	○	○	DP5	<div style="border: 1px solid black; padding: 2px; display: inline-block;">Hz</div> <div style="border: 1px solid black; padding: 2px; display: inline-block;">M</div> <div style="border: 1px solid black; padding: 2px; display: inline-block;">S</div> <div style="border: 1px solid black; padding: 2px; display: inline-block;">K</div> <div style="border: 1px solid black; padding: 2px; display: inline-block;">μ</div> <div style="border: 1px solid black; padding: 2px; display: inline-block;">765432 10</div> <div style="border: 1px solid black; padding: 2px; display: inline-block;">765432 10</div> <div style="border: 1px solid black; padding: 2px; display: inline-block;">765432 10</div> <div style="border: 1px solid black; padding: 2px; display: inline-block;">765432 10</div> <div style="border: 1px solid black; padding: 2px; display: inline-block;">765432 10</div>
○	→	Hz																															
○	○	M																															
○	○	S																															
○	○	K																															
○	○	μ																															
○	○	DP1																															
○	○	DP2																															
○	○	DP3																															
○	○	DP4																															
○	○	DP5																															
b.		(28) ○																															
		(29) ○																															
		(30) ○																															
		(31) ○																															
		(33) ○																															
		(34) ○																															
		(46) ○																															
		(47) ○																															
		(48) ○																															

Table 5-4. Tests 9, 10, 11, 12, 13, 14, 15, and 16

TEST 9 (SAME AS DIAGNOSTIC CARD NO. C) MOS "TIME BASE AND COUNTER CHECK"				
Pin No.	Connected To	Pin No.	Description (Lines Connected Together)	Display Should Be
(4)	—————>	(9)	Gnd/Open, $\overline{\text{Print}}$ and $\overline{\text{Transfer}}$	 Accumulate one digit per 10 seconds
		(20), (19)		
(5)	—————>	(18)	$F_1$ /Time Base Output	
(7)	—————>	(16)	$F_2$ /Clock	
(36)	—————>	(37)	Digit Address "X"/Digit Select "X"	
(38)	—————>	(39)	Digit Address "Y"/Digit Select "Y"	
(40)	—————>	(41)	Digit Address "Z"/Digit Select "Z"	
(50)	—————>	(25)	DC-IN (+22 V)	
<p>TEST 10 (SAME AS DIAGNOSTIC CARD NO. C) or Test 9, and connect pins listed in TEST 9 and ground pin 22, Time Base Select "A".</p>  Accumulate one digit per second				
<p>TEST 11 (SAME AS DIAGNOSTIC CARD NO. C) or Test 9, and connect pins listed in TEST 9 and ground pin 23, Time Base Select "B".</p>  Accumulate one digit per second				
<p>TEST 12 (SAME AS DIAGNOSTIC CARD NO. C) or Test 9, and connect pins listed in TEST 9 and ground pins 22 and 23, Time Base Select "A", "B".</p>  Accumulate on digit per second				
<p>TEST 13 (SAME AS DIAGNOSTIC CARD NO. D) or Test 9, and connect pins listed in TEST 9 and ground pin 24, Time Base Select "C".</p>  Accumulate one digit per second				
<p>TEST 14 (SAME AS DIAGNOSTIC CARD NO. D) or Test 9, and connect pins listed in TEST 9 and ground pins 22 and 24, Time Base Select "A", "C".</p>  Accumulate one digit per second				
<p>TEST 15 (SAME AS DIAGNOSTIC CARD NO. D) or Test 9, and connect pins listed in TEST 9 and ground pins 23 and 24, Time Base Select "B", "C".</p>  Accumulate one digit per second				
<p>TEST 16 (SAME AS DIAGNOSTIC CARD NO. D) or Test 9, and connect pins listed in TEST 9 and ground pins 22, 23, and 24, Time Base Select "A", "B", "C".</p>  Accumulate one digit per second				
				<p>"Overflow" should indicate in approximately 10 seconds.</p>



### OSCILLATOR ADJUSTMENT (Continued)

c. The 5345A or 5245L/M display should read 10.00000 MHz  $\pm 1$  count.

d. If the 5345A or 5245L/M does not indicate this frequency, adjust the 5300B OSC adjustment until the display is correct. Adjust for square wave output signal as explained in NOTE 3 and/or 5 on schematic diagrams.

5-55. The Standard 5300B 10 MHz oscillator can be adjusted through the rear panel access hole. Adjustment should be made with the 5300B mated to a plug-on as part of a periodic maintenance cycle.

#### 5-56. Standard Oscillator Measured by Oscilloscope-Drift Method

5-57. The 5300B oscillator may be adjusted against a reference or "house" standard using the oscilloscope-drift method. With this method, drift in "parts in  $10^8$ " can be monitored. To adjust the oscillator proceed as follows:

a. Connect 5300B rear panel OSC jack to oscilloscope vertical input.

b. Connect the Standard Reference 5 MHz source to the oscilloscope external horizontal input jack.

c. Set the oscilloscope time/cm to its fastest sweep time. Set the oscilloscope triggering to external.

d. Adjust the oscilloscope vertical amplifier controls and the time base controls until the oscilloscope display is exactly 10 cycles of the oscillator waveforms.

e. The oscilloscope display should be a stationary pattern. Unless the 5300B oscillator frequency and reference standard frequency are identical, the display on the oscilloscope will drift left or right. A left drift indicates the counter oscillator frequency is higher than the standard frequency. A right drift indicates the counter oscillator frequency is lower than the standard frequency. The rate of movement is related to the frequency difference between the 5300B oscillator and the standard frequency as shown in the following example.

Example. A 5 MHz frequency is used to trigger the oscilloscope sweep; the oscilloscope vertical amplifier signal is the 5300B oscillator frequency. The time required for the pattern to drift the width of one cycle for the display is (in this example) 10 seconds. The frequency error is:

$$\frac{\Delta f}{f} = \frac{\Delta t}{t} = \frac{2 \times 10^{-7}}{1 \times 10} = 2 \times 10^{-8} = 2 \text{ parts in } 10^8 \text{ error.}$$

f. Longer measurement periods are required to observe smaller frequency differences.

g. If frequency difference (drift) is excessive adjust 5300B rear-panel OSC ADJ. Adjust for square wave output as explained in NOTE 3 and/or 5 on schematic diagrams.

#### 5-58. Option 001 High Stability Time Base (TCXO) Measurement and Adjustment

5-59. Measurement and adjustment of the Option 001 High Stability Time Base (TCXO) is similar to measurement and adjustment of the standard time base oscillator. Use the standard oscillator measurement and adjustment procedures with the following two exceptions.

a. Adjustment must be made with an ambient temperature of 25°C. See Figure 7-1 or 8-4 for information applicable to instruments with different serial prefixes. Loading at OSC jack J2 must be 200Ω or higher.

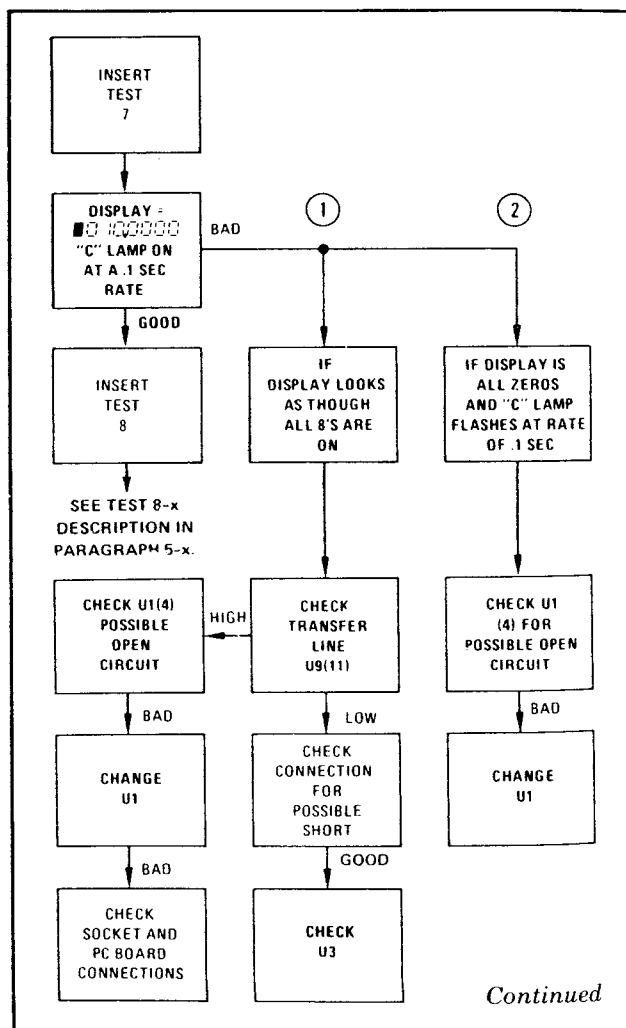

Continued

Figure 5-6. A1U1 Counter, A1U2 Time Base, and A1U9 Control Checks (Continued on next page)

**NOTE**

With Test 7 either of two correct displays are possible:

The difference between the two displays is the standard plus or minus one count specification.

The table below lists possible incorrect displays and possible causes with test card B and Test 7.

Alternative Incorrect Displays		Possible Cause
		Pin of U14 Forced LOW
3009.9999 MHz C	30 10.0000 MHz C	2
████████.████████ MHz C	████████.████████ MHz C	4
████████.9999 MHz C	████████ 1.████████ MHz C	5
700 1.1111 MHz C	70 10.0000 MHz C	6
████████.8888 MHz C	70 10.0000 MHz C	7
1 088.8888 MHz C	1 0 10.0000 MHz C	9
- 009.9999 MHz C	- 0 10.0000 MHz C	10
1009.9999 MHz C	10 10.0000 MHz C	11
1009.9999 MHz C	10 10.0000 MHz C	12
- 009.9999 MHz C	- 0 70.0000 MHz C	13
- 889.9999 MHz C	- 8 18.8888 MHz C	14
1 009.9999 MHz C	1 0 10.0000 MHz C	15

*Continued*

Figure 5-6. A1U1 Counter, A1U2 Time Base, and A1U9 Control Checks (Continued)

Alternative Incorrect Displays		Possible Cause
		Pin Check if Pin of U14 is Forced HIGH
223.3333 MHz C	232.2222 MHz C	1
44. MHz C	954.4444 MHz C	2
889.9999 MHz C	890.8888 MHz C	6
119.9999 MHz C	111.1111 MHz C	7
009.9999 MHz C	0 10.0000 MHz C	9
009.9999 MHz C	0 10.0000 MHz C	10
000.0000 MHz C	0 10.0000 MHz C	11
009.9999 MHz C	0 10.0000 MHz C	12
004.4444 MHz C	0 10.0000 MHz C	13
007.7777 MHz C	0 10.0000 MHz C	14
007.7777 MHz C	000.0000 MHz C	15

\*CORRECT DISPLAY

Figure 5-6. A1U1 Counter, A1U2 Time Base, and A1U9 Control Checks (Continued)

b. Access to adjustment of the 5300B Option 001 TCXO is inside the top cover of the 5300B. (Refer to Paragraph 5-5 for cover removal instructions.) A small screw covers the TCXO adjustment access in the TCXO unit. See the Option 001 component locator figure in Section VIII.

#### 5-60. HP 5310A BATTERY PACK

#### 5-61. Battery Capacity Check

### CAUTION

Maximum battery recharge time is 24 hours. Batteries may be damaged by heat if limit is exceeded.

5-62. The condition of the batteries in Model 5310A Battery Pack can be checked using equipment listed in Table 5-1 as follows:

a. Mate the 5310A Battery Pack to the 5300B Measuring System mainframe and the plug-on in use using procedure in Paragraphs 2-15, 2-16, and 2-17.

b. Unplug the 5300B ac line cord and set 5310A switch to BATTERY so that the battery pack is operating with normal load and supplying power to the Measuring System/Plug-on combination.

c. If the LOW BATTERY lamp starts to glow or if short battery life has been experienced, the Battery Pack should be recharged as follows:

1. Connect ac line power to 5300B. (Note: it is not necessary to have plug-on connected to charge batteries.)
2. Set panel switch to CHARGE for 18 hours.
3. After 18 hours, disconnect ac power and set panel switch to LINE.

d. Ensure that the panel switch is set to LINE, then separate the Battery Pack from the 5300B and plug-on combination.

e. Connect a load across Battery Pack as follows:

1. Remove the Battery Pack top cover by removing the six attaching screws.
2. Obtain a 10-ohm, 25 W resistor and a 50-pin, female connector, HP Part No. 1251-0101 (CINCH 57-20500-375).
3. Solder the resistor between pins 25 and 49 of this connector.

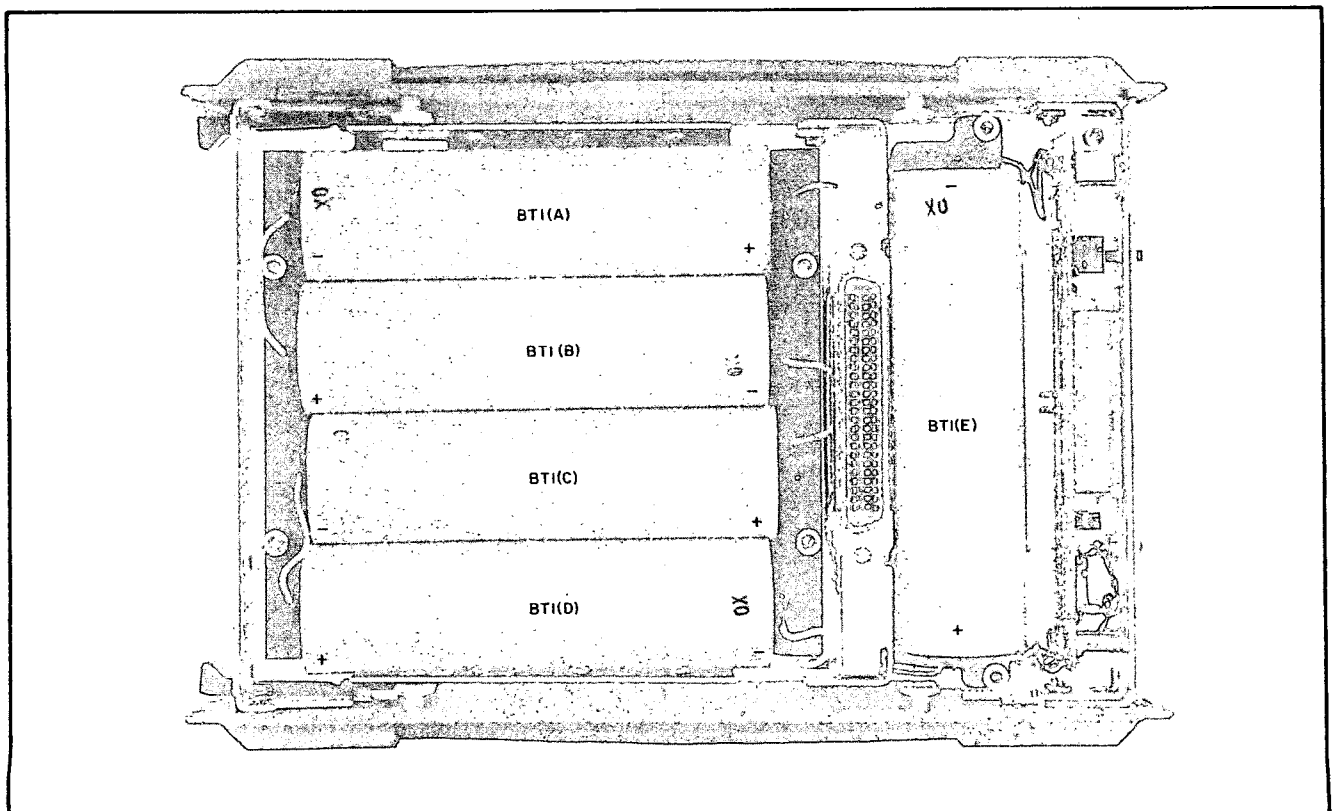

Figure 5-7. Battery Removal

4. Connect the loaded female connector to the Battery Pack bottom connector, A1J1.

f. Set Battery Pack switch to BATTERY.

g. Check the voltage conditions of each of the five batteries with a dc voltmeter. The normal voltage for each battery should be greater than 2 volts (about 2.3 to 2.8V depending on time since charge) and each battery should be nearly the same level. A difference in voltage level between batteries is an indication that the lower voltage batteries are faulty and should be replaced.

h. Following an 18-hour charge, the Battery Pack should operate with a 10-ohm load for about 2.5 hours. The total battery voltage after this time should be greater than +10 volts dc.

i. If above tests indicate that battery capacity is lower than normal, full capacity can sometimes be regained by exercising the batteries through several charge-discharge cycles. Batteries may be loaded separately with 10-ohm, 25-watt resistors, for various lengths of time, until the capacities of all batteries are the same (all batteries measure 1.5 volts under load, for example). In some cases, full capacity may be obtained after charging the entire Battery Pack for 18 hours in the normal manner.

j. The battery pack should be checked and recharged every 30 days as part of a regular maintenance cycle.

k. On days when the Battery Pack is used continuously for 3 to 8 hours (depending on plug-on used), it should be recharged over night.

### 5-63. Replacing Internal Battery Supply (see Figure 5-7)

5-64. If the procedure of Paragraph 5-61 establishes that the 5310A internal batteries do not provide power for the normal operating time, replace the batteries. The batteries must be replaced with power removed and battery pack separated from the 5300B and plug-on used. Hewlett-Packard recommends replacing all five batteries. Installing only one new battery may result in decreased operating life of the older batteries or the newer replacement due to differences in battery capacity with age. If single battery replacement is attempted, however, batteries from different manufacturers must not be intermixed. This unit contains one of the following battery types:

HP Part No.	Manufacturer	Mfg. No.
1420-0084 (no identifying numbers on battery)	Union Carbide Corp. Elect. Div.	Y 5816
1420-0209 (Part Number located on battery)	Gould-National Batteries, Inc.	--

Replace batteries as follows:

### **WARNING**

**WHILE PERFORMING THE FOLLOWING STEPS, ENSURE THAT THE BATTERY LEADS ARE NOT SHORTED TO EACH OTHER OR TO THE INSTRUMENT CHASSIS. INJURY TO PERSONNEL AND/OR DAMAGE TO EQUIPMENT MAY OTHERWISE OCCUR.**

a. Remove fuse F1 (located on A1 Assembly at front of 5310A) using a nonconductive tool.

b. Remove six screws in top cover plate and lift off plate to expose the five batteries.

c. Unsolder WHT-BLK-RED wire, at BT1A(+), which leads from A2(H) to BT1A(+).

d. Unsolder WHT wire at BT1D(-). Four batteries, BT1A, B, C, and D will be free for removal.

e. Unsolder WHT wire at BT1E(+) and BLK wire at BT1E(-). The last section of the battery will be free for removal.

f. Interconnections between the four sections of BT1A, B, C, and D can be made with the batteries out of the casting.

g. The battery sections can be reinstalled by reversing steps a through e.

h. When the five sections of BT1 have been installed, the plate removed in step b can be replaced and the six screws installed.

i. Mate the 5310A Battery Pack to the 5300B and the plug-on used as in Paragraph 2-15.

### 5-65. Removing A2 Power Supply Board

5-66. To remove the A2 Power Supply Board, remove the batteries using procedures in Paragraph 5-64, steps a to e. Remove the A2 board as follows:

a. Unsolder the BLK wire connected to A2(A).

b. Unsolder the WHT-BLK-ORN wire connected to A2(C).

c. Unsolder the BLK wire from LOW BATTERY lamp connected to A2(D) and the GRN wire connected to A2(E).

d. Unsolder WHT-RED wire connected to A2(F).

e. Unsolder the WHT-BRN-RED wire connected to A2(G).

f. Unsolder the WHT-BLK-RED wire connected to A2(H).

g. Unsolder the BLK wire connected to A2(B).

h. Using an offset cross-type screwdriver, remove the three screws securing A2. Loosen screw securing the plastic power transistor.

i. The A2 Assembly should now be free for removal.

j. To install A2 Assembly, reverse the procedures of steps a to i.

## SECTION VI REPLACEABLE PARTS

### 6-1. INTRODUCTION

6-2. This section contains information for ordering replacement parts. Tables 6-1 and 6-2 list parts used in the HP 5300B, and 5310A. The table lists parts in alphanumeric order of their reference designations and provides the following information on each part:

- a. Hewlett-Packard part number.
- b. Description of part (see abbreviations below).
- c. Total quantity used in the instrument (the first time that the part appears in the list, the total quantity of that part number is printed).
- d. Typical manufacturer of the part in a five-digit code (see list of manufacturers in Table 6-3).
- e. Manufacturer's part number.

6-3. Miscellaneous parts are listed at the end of Table 6-1 and 6-2.

### 6-4. ORDERING INFORMATION

6-5. To obtain replacement parts, address order or inquiry to your local Hewlett-Packard Sales and Service Office (see lists at rear of this Section for addresses). Identify parts by their Hewlett-Packard part number. To obtain a part that is not listed, include:

- a. Instrument model number.
- b. Instrument serial number.
- c. Description of the part.
- d. Function and location of the part.

### REFERENCE DESIGNATIONS

A	= assembly	E	= miscellaneous electrical part	P	= electrical connector (movable portion); plug	U	= integrated circuit; microcircuit
AT	= attenuator; isolator; termination	F	= fuse	Q	= transistor; SCR; triode thyristor	V	= electron tube
B	= fan; motor	FI	= filter	R	= resistor	VR	= voltage regulator; breakdown diode
BT	= battery	H	= hardware	RT	= thermistor	W	= cable; transmission path; wire
C	= capacitor	HY	= circulator	S	= switch	X	= socket
CP	= coupler	J	= electrical connector (stationary portion); jack	T	= transformer	Y	= crystal unit-piezoelectric
CR	= diode; diode thyristor; varactor	K	= relay	TB	= terminal board	Z	= tuned cavity; tuned circuit
DC	= directional coupler	L	= coil; inductor	TC	= thermocouple		
DL	= delay line	M	= meter	TP	= test point		
DS	= annunciator; signaling device (audible or visual); lamp; LED	MP	= miscellaneous mechanical part				

### ABBREVIATIONS

A	= ampere	avg	= average	CHAN	= channel	dc	= direct current
ac	= alternating current	AWG	= American wire gauge	cm	= centimeter	deg	= degree (temperature interval or difference)
ACCESS	= accessory	BAL	= balance	CMO	= cabinet mount only	°	= degree (plane angle)
ADJ	= adjustment	BCD	= binary coded decimal	COAX	= coaxial	°C	= degree Celsius (centigrade)
A/D	= analog-to-digital	BD	= board	COEF	= coefficient	°F	= degree Fahrenheit
AF	= audio frequency	BE CU	= beryllium copper	COM	= common	°K	= degree Kelvin
AFC	= automatic frequency control	BFO	= beat frequency oscillator	COMP	= composition	DEPC	= deposited carbon
AGC	= automatic gain control	BH	= binder head	COMPL	= complete	DET	= detector
AL	= aluminum	BKDN	= breakdown	CONN	= connector	diam	= diameter
ALC	= automatic level control	BP	= bandpass	CP	= cadmium plate	DIA	= diameter (used in parts list)
AM	= amplitude modulation	BPF	= bandpass filter	CRT	= cathode-ray tube	DIFF	= differential amplifier
AMPL	= amplifier	BRS	= brass	CTI	= complementary transistor logic	div	= division
APC	= automatic phase control	BWO	= backward-wave oscillator	CW	= continuous wave	DPIYT	= double-pole, double-throw
ASSY	= assembly	CAL	= calibrate	cw	= clockwise	DR	= drive
AUX	= auxiliary	ccw	= counterclockwise	cm	= centimeter		
		CER	= ceramic	D/A	= digital-to-analog		
				dB	= decibel		
				dBm	= decibel referred to 1 mW		

ABBREVIATIONS

DSB = double sideband	MFR = manufacturer	PIV = peak inverse voltage	TFT = thin-film transistor
DTL = diode transistor logic	mg = milligram	pk = peak	TGL = toggle
DVM = digital voltmeter	MHz = megahertz	PL = phase lock	THD = thread
ECL = emitter coupled logic	mH = millihenry	PLO = phase lock oscillator	THRU = through
EMF = electromotive force	mho = mho	PM = phase modulation	TI = titanium
EDP = electronic data processing	MIN = minimum	PNP = positive-negative-positive	TOI = tolerance
ELECT = electrolytic	min = minute (time)	POS = positive	TRIM = trimmer
ENCAP = encapsulated	MINAT = miniature	P:O = part of	TSTR = transistor
EXT = external	mm = millimeter	POLY = polystyrene	TTL = transistor-transistor logic
F = farad	MOD = modulator	PORC = porcelain	TV = television
FET = field-effect transistor	MOM = momentary	POS = positive; position(s) (used in parts list)	TVI = television interference
F/F = flip-flop	MOS = metal-oxide semiconductor	POT = potentiometer	TWT = traveling wave tube
FH = flat head	ms = millisecond	p-p = peak-to-peak	U = micro (10 <sup>-6</sup> ) (used in parts list)
FIL. H = fillister head	MTG = mounting	PP = peak-to-peak (used in parts list)	UF = microfarad (used in parts list)
FM = frequency modulation	MTR = meter (indicating device)	PPM = pulse-position modulation	UHF = ultrahigh frequency
FP = front panel	mV = millivolt	PREAMPL. = preamplifier	UNREG = unregulated
FREQ = frequency	mVac = millivolt, ac	PRF = pulse-repetition frequency	V = volt
FXD = fixed	mVdc = millivolt, dc	PRR = pulse repetition rate	VA = voltampere
g = gram	mVpk = millivolt, peak	PS = picosecond	Vac = volts, ac
GE = germanium	mV p-p = millivolt, peak-to-peak	PT = point	VAR = variable
GHz = gigahertz	mVrms = millivolt, rms	PTM = pulse-time modulation	VCO = voltage-controlled oscillator
GL = glass	mW = milliwatt	PWM = pulse-width modulation	Vdc = volts, dc
GND = ground(ed)	MUX = multiplex	PWV = peak working voltage	VDCW = volts, dc, working (used in parts list)
H = henry	MY = mylar	RC = resistance capacitance	V(F) = volts, filtered
h = hour	μA = microampere	RECT = rectifier	VFO = variable-frequency oscillator
HET = heterodyne	μF = microfarad	REF = reference	VHF = very-high frequency
HEX = hexagonal	μH = microhenry	REG = regulated	Vpk = volts, peak
HD = head	μmho = micromho	REPL. = replaceable	Vp-p = volts, peak-to-peak
HDW = hardware	μs = microsecond	RF = radio frequency	Vrms = volts, rms
HF = high frequency	μV = microvolt	RFI = radio frequency interference	VSWR = voltage standing wave ratio
HG = mercury	μVac = microvolt, ac	RH = round head; right hand	VTO = voltage-tuned oscillator
HI = high	μVdc = microvolt, dc	RLC = resistance-inductance-capacitance	VTVM = vacuum-tube voltmeter
HP = Hewlett-Packard	μVpk = microvolt, peak	RMO = neon	V(X) = volts, switched
HPF = high pass filter	μVp-p = microvolt, peak-to-peak	rms = root-mean-square	W = watt
HR = hour (used in parts list)	μVrms = microvolt, rms	RNI = round	W = with
HV = high voltage	nA = nanoampere	ROM = read-only memory	WIV = working inverse voltage
Hz = Hertz	NC = no connection	R&P = rack and panel	WW = wirewound
IC = integrated circuit	N/C = normally closed	RWV = reverse working voltage	W/O = without
ID = inside diameter	NE = neon	S = scattering parameter	YIG = yttrium-iron-garnet
ID = intermediate frequency	NEG = negative	S = second (time)	Zo = characteristic impedance
IMP.G = impregnated	NEG = negative	S-B = second (plane angle)	
in = inch	NEF = negative-positive-zero (zero temperature coefficient)	SCR = silicon controlled rectifier; screw	
INCD = incandescent	nF = nanofarad	SE = selenium	
INCL = include(s)	NI PL. = nickel plate	SECT = sections	
INP = input	N/O = normally open	SEMICON = semiconductor	
INS = insulation	NOM = nominal	SHF = superhigh frequency	
INT = internal	NORM = normal	SI = silicon	
kg = kilogram	NPN = negative-positive-negative	SIL = silver	
kHz = kilohertz	NPO = negative-positive zero (zero temperature coefficient)	SL = slide	
kΩ = kilohm	NRFR = not recommended for field replacement	SNR = signal-to-noise ratio	
kV = kilovolt	NSR = not separately replaceable	SPDT = single-pole, double-throw	
lb = pound	ns = nanosecond	SPG = spring	
LC = inductance-capacitance	nW = nanowatt	SR = split ring	
LED = light-emitting diode	OBD = order by description	SPST = single-pole, single-throw	
LF = low frequency	OD = outside diameter	SSB = single sideband	
LG = long	OH = oval head	SST = stainless steel	
LH = left hand	OP AMPL. = operational amplifier	STL = steel	
LIM = limit	OPT = option	SQ = square	
LIN = linear taper (used in parts list)	OSC = oscillator	SWR = standing-wave ratio	
lin = linear	OX = oxide	SYNC = synchronize	
LK = lock washer	oz = ounce	T = timed (slow-blow fuse)	
WASH = lock washer	Ω = ohm	TA = tantalum	
LO = low; local oscillator	P = peak (used in parts list)	TC = temperature compensating	
LOG = logarithmic taper (used in parts list)	PAM = pulse-amplitude modulation	TD = time delay	
log = logarithmic	PC = printed circuit	TERM = terminal	
LPF = low pass filter	PCM = pulse-code modulation; pulse-count modulation		
LV = low voltage	PDM = pulse-duration modulation		
m = meter (distance)	pF = picofarad		
mA = milliampere	PH BRZ. = phosphor bronze		
MAX = maximum	PHI. = Phillips		
MΩ = megohm	PIN = positive-intrinsic-negative		
MEG = meg (10 <sup>6</sup> ) (used in parts list)			
MET FILM = metal film			
MET OX = metal oxide			
MF = medium frequency; microfarad (used in parts list)			

MULTIPLIERS

Abbreviation	Prefix	Multiple
T	tera	10 <sup>12</sup>
G	giga	10 <sup>9</sup>
M	mega	10 <sup>6</sup>
k	kilo	10 <sup>3</sup>
da	deka	10
d	deci	10 <sup>-1</sup>
c	centi	10 <sup>-2</sup>
m	milli	10 <sup>-3</sup>
μ	micro	10 <sup>-6</sup>
n	nano	10 <sup>-9</sup>
p	pico	10 <sup>-12</sup>
f	femto	10 <sup>-15</sup>
a	atto	10 <sup>-18</sup>

**NOTE**  
All abbreviations in the parts list will be in upper case.



Table 6-1A. 5300B Standard Instrument, Replaceable Parts

Reference Designation	HP Part Number	Qty	Description	Mfr Code	Mfr Part Number
A1	05300-60017	1	BOARD ASSY, LOGIC (SERIES 1704)	28480	05300-60017
A1C1	0180-0229	1	CAPACITOR-FXD: 33UF+-10% 10VDC TA-SOLID	56289	1500336X901082
A1C2	0150-0050	1	CAPACITOR-FXD 1000PF +80-20% 1000WVDC	28480	0150-0050
A1C3	0150-0071	2	CAPACITOR-FXD 400PF +-5% 1000WVDC CER	28480	0150-0071
A1C4	0150-0075	2	CAPACITOR-FXD 4700PF +100-20% 500WVDC	28480	0150-0075
A1C5	0150-0075	2	CAPACITOR-FXD 4700PF +100-20% 500WVDC	28480	0150-0075
A1C6	0180-2357	1	C:FXD TA 950 UF 90VDCW	28480	0180-2357
A1C7	0160-2055	2	CAPACITOR-FXD .01UF +80-20% 100WVDC CER	28480	0160-2055
A1C8	0160-0161	1	CAPACITOR-FXD .01UF +-10% 200WVDC POLYE	56289	292P10392
A1C9	0150-0096	1	CAPACITOR-FXD .05UF +80-20% 100WVDC CER	28480	0150-0096
A1C10	0121-0061	1	CAPACITOR; VAR; TRMR; CER; 5.5/18PF	73899	0V11PS18A
A1C11	0121-0059	1	CAPACITOR; VAR; TRMR; CER; 2/8PF	73899	0V11PR8A
A1C12	0160-2257	1	CAPACITOR-FXD 10PF +-5% 500WVDC CER	28480	0160-2257
A1C13	0160-3879	1	CAPACITOR-FXD .01UF +-20% 100WVDC CER	28480	0160-3879
A1C14	0150-0071	1	CAPACITOR-FXD 400PF +-5% 1000WVDC CER	28480	0150-0071
A1C15	0160-2055	1	CAPACITOR-FXD .01UF +80-20% 100WVDC CER	28480	0160-2055
A1C16	0180-1773	1	CAPACITOR-FXD: .68 UF +-5% 35VDC TA	56289	1500684X5035A2
A1C17	0180-0428	2	CAPACITOR-FXD: 68UF+-20% 6VDC TA-SOLID	28480	0180-0428
A1C18	0180-0557	2	CAPACITOR-FXD 150UF +100-10% 6VDC AL	90201	MTV150C06
A1C19	0180-0554	1	CAPACITOR-FXD: 150UF+-20% 6VDC TA-SOLID	28480	0180-0554
A1C20	0180-0551	2	CAPACITOR-FXD 35UF +100-10% 25VDC AL	90201	MTV35C825
A1C21	0180-0551	1	CAPACITOR-FXD 35UF +100-10% 25VDC AL	90201	MTV35C825
A1C22	0180-0557	1	CAPACITOR-FXD 150UF +100-10% 6VDC AL	90201	MTV150C06
A1C23	0180-0373	1	*CAPACITOR-FXD: 68UF+-20% 35VDC TA	56289	1500684X9035A2
A1C24	0180-0552	2	CAPACITOR-FXD: 220UF+-20% 10VDC TA	28480	0180-0552
A1C25	0180-0552	2	CAPACITOR-FXD: 220UF+-20% 10VDC TA	28480	0180-0552
A1C26	0180-0428	2	CAPACITOR-FXD: 68UF+-20% 6VDC TA-SOLID	28480	0180-0428
A1C27	0180-0553	2	CAPACITOR-FXD: 22UF+-20% 25VDC TA-SOLID	28480	0180-0553
A1C28	0180-0553	2	CAPACITOR-FXD: 22UF+-20% 25VDC TA-SOLID	28480	0180-0553
A1C29	0180-0161	1	CAPACITOR-FXD: 3.3UF+-20% 35VDC TA	56289	1500335X0035B2
A1C30	0160-2204	1	CAPACITOR-FXD 100PF +-5% 300WVDC MICA	28480	0160-2204
A1CR1	1901-0028	7	DIODE-PWR RECT 400V 750MA	04713	SR1358-9
A1CR2	1901-1081	2	DIODE-PWR RECT 100V 3A	28480	1901-1081
A1CR3	1901-0028	2	DIODE-PWR RECT 400V 750MA	04713	SR1358-9
A1CR4	1901-1081	2	DIODE-PWR RECT 100V 3A	28480	1901-1081
A1CR5	1901-0028	2	DIODE-PWR RECT 400V 750MA	04713	SR1358-9
A1CR6	1901-0028	2	DIODE-PWR RECT 400V 750MA	04713	SR1358-9
A1CR7	1901-0028	2	DIODE-PWR RECT 400V 750MA	04713	SR1358-9
A1CR8	1902-3205	1	DIODE-ZNR 15V 5% DO-7 PD=.4W TC=+.057%	04713	SZ 10939-233
A1CR9	1901-0050	1	DIODE-SWITCHING 2N5 80V 200MA	28480	1901-0050
A1CR10	1902-3381	1	DIODE-ZNR 68.1V 5% DO-7 PD=.4W	04713	SZ 10939-422
A1CR11	1901-0028	1	DIODE-PWR RECT 400V 750MA	04713	SR1358-9
A1CR12	1901-0028	1	DIODE-PWR RECT 400V 750MA	04713	SR1358-9
A1J1	1251-2564	1	CONNECTOR, 50-CONT, MALE, MICRO RIBBON	71785	57-10500-27
FOR A1J1	0905-0479	1	GASKET, TEFLON	28480	0905-0479
A1L1	9100-3139	5	COIL:75 UH	28480	9100-3139
A1L2	9100-3139	5	COIL:75 UH	28480	9100-3139
A1L3	9100-3139	5	COIL:75 UH	28480	9100-3139
A1L4	9100-3139	5	COIL:75 UH	28480	9100-3139
A1L5	9100-3139	5	COIL:75 UH	28480	9100-3139
A1L6	9140-0210	1	COIL; FXD; MOLDED RF CHOKE; 100UH 5%	24226	15/103
A1Q1	1854-0215	2	TRANSISTOR NPN SI PD=310MW FT=300MHZ	04713	SPS 3611
A1Q2	1853-0318	8	TRANSISTOR PNP SI CHIP PD=500MW	28480	1853-0318
A1Q3	1853-0318	8	TRANSISTOR PNP SI CHIP PD=500MW	28480	1853-0318
A1Q4	1853-0318	8	TRANSISTOR PNP SI CHIP PD=500MW	28480	1853-0318
A1Q5	1853-0318	8	TRANSISTOR PNP SI CHIP PD=500MW	28480	1853-0318
A1Q6	1853-0318	8	TRANSISTOR PNP SI CHIP PD=500MW	28480	1853-0318
A1Q7	1853-0318	8	TRANSISTOR PNP SI CHIP PD=500MW	28480	1853-0318
A1Q8	1853-0318	8	TRANSISTOR PNP SI CHIP PD=500MW	28480	1853-0318
A1Q9	1853-0318	8	TRANSISTOR PNP SI CHIP PD=500MW	28480	1853-0318
A1Q10	1853-0015	2	TRANSISTOR PNP SI CHIP PD=200MW	28480	1853-0015
A1Q11	1853-0015	2	TRANSISTOR PNP SI CHIP PD=200MW	28480	1853-0015
A1Q12	1853-0036	3	TRANSISTOR PNP SI CHIP PD=310MW	28480	1853-0036
A1Q13	1853-0036	3	TRANSISTOR PNP SI CHIP PD=310MW	28480	1853-0036
A1Q14	1853-0036	3	TRANSISTOR PNP SI CHIP PD=310MW	28480	1853-0036
A1Q15	1854-0215	2	TRANSISTOR NPN SI PD=310MW FT=300MHZ	04713	SPS 3611
A1Q16	1854-0492	1	TRANSISTOR NPN SI PD=350MW FT=250MHZ	28480	1854-0492
A1R1	0683-2025	3	RESISTOR 2K 5% .25W CC TUBULAR	01121	CB2025
A1R2	0683-6215	2	RESISTOR 620 OHM 5% .25W CC TUBULAR	01121	CB6215
A1R3	0683-3915	1	RESISTOR 390 OHM 5% .25W CC TUBULAR	01121	CB3915
A1R4	0683-1035	4	RESISTOR 10K 5% .25W CC TUBULAR	01121	CB1035
A1R5	1810-0055	2	NETWORK-RES 9-PIN SIP .15-PIN-SPCG	28480	1810-0055

\*FACTORY SELECTED VALUE

See introduction to this section for ordering information

Models 5300B and 5310A  
Replaceable Parts

Table 6-1A. 5300B Standard Instrument, Replaceable Parts (Cont'd)

Reference Designation	HP Part Number	Qty	Description	Mfr Code	Mfr Part Number
A1R6	0683-1035		RESISTOR 10K 5% .25W CC TUBULAR	01121	C81035
A1R7	0683-1035		RESISTOR 10K 5% .25W CC TUBULAR	01121	C81035
A1R8	0683-1055	1	RESISTOR 1M 5% .25W CC TUBULAR	01121	C81055
A1R9	0683-1525	5	RESISTOR 1.5K 5% .25W CC TUBULAR	01121	C81525
A1R10	0698-4037	1	RESISTOR 46.4 OHM 1% .125W F TUBULAR	16299	C4-1/8-T0-46R4-F
A1R11	0683-1025	4	RESISTOR 1K 5% .25W CC TUBULAR	01121	C81025
A1R12	0683-1525		RESISTOR 1.5K 5% .25W CC TUBULAR	01121	C81525
A1P13	0683-1525		RESISTOR 1.5K 5% .25W CC TUBULAR	01121	C81525
A1R14	0683-1035		RESISTOR 10K 5% .25W CC TUBULAR	01121	C81035
A1R15	1810-0055		NETWORK-RES 9-PIN SIP .15-PIN-SPCG	28480	1810-0055
A1R16	0683-7515	2	RESISTOR 750 OHM 5% .25W CC TUBULAR	01121	C87515
A1R17	0683-2015	8	RESISTOR 200 OHM 5% .25W CC TUBULAR	01121	C82015
A1R18	0683-2015		RESISTOR 200 OHM 5% .25W CC TUBULAR	01121	C82015
A1F19	0683-2015		RESISTOR 200 OHM 5% .25W CC TUBULAR	01121	C82015
A1F20	0683-2015		RESISTOR 200 OHM 5% .25W CC TUBULAR	01121	C82015
A1R21	0683-7515		RESISTOR 750 OHM 5% .25W CC TUBULAR	01121	C87515
A1R22	0683-6805	1	RESISTOR 68 OHM 5% .25W CC TUBULAR	01121	C86805
A1R23	0683-1525		RESISTOR 1.5K 5% .25W CC TUBULAR	01121	C81525
A1R24	0683-1525		RESISTOR 1.5K 5% .25W CC TUBULAR	01121	C81525
A1R25			NOT ASSIGNED		
A1R26	0683-2715	2	RESISTOR 270 OHM 5% .25W CC TUBULAR	01121	C82715
A1R27	0683-8215		RESISTOR 820 OHM 5% .25W CC TUBULAR	01121	C88215
A1R28			NOT ASSIGNED		
A1R29			NOT ASSIGNED		
A1P30	0683-2015		RESISTOR 200 OHM 5% .25W CC TUBULAR	01121	C82015
A1P31	0683-2015		RESISTOR 200 OHM 5% .25W CC TUBULAR	01121	C82015
A1R32	0683-2015		RESISTOR 200 OHM 5% .25W CC TUBULAR	01121	C82015
A1R33	0683-2015		RESISTOR 200 OHM 5% .25W CC TUBULAR	01121	C82015
A1R34	0683-1025		RESISTOR 1K 5% .25W CC TUBULAR	01121	C81025
A1R35	0683-2035	1	RESISTOR 20K 5% .25W CC TUBULAR	01121	C82035
A1R36	0683-1015	1	RESISTOR 100 OHM 5% .25W CC TUBULAR	01121	C81015
A1P37	0693-2025		RESISTOR 2K 5% .25W CC TUBULAR	01121	C82025
A1R38	0683-1025		RESISTOR 1K 5% .25W CC TUBULAR	01121	C81025
A1R39	0683-2715		RESISTOR 270 OHM 5% .25W CC TUBULAR	01121	C82715
A1R40	0683-1505	1	RESISTOR 15 OHM 5% .25W CC TUBULAR	01121	C81505
A1R41	0683-3305	7	RESISTOR 33 OHM 5% .25W CC TUBULAR	01121	C83305
A1R42	0683-3305		RESISTOR 33 OHM 5% .25W CC TUBULAR	01121	C83305
A1R43	0683-3305		RESISTOR 33 OHM 5% .25W CC TUBULAR	01121	C83305
A1R44	0683-3305		RESISTOR 33 OHM 5% .25W CC TUBULAR	01121	C83305
A1R45	0683-3305		RESISTOR 33 OHM 5% .25W CC TUBULAR	01121	C83305
A1R46	0683-3305		RESISTOR 33 OHM 5% .25W CC TUBULAR	01121	C83305
A1R47	0683-3305		RESISTOR 33 OHM 5% .25W CC TUBULAR	01121	C83305
A1R48	0683-1005	1	RESISTOR 10 OHM 5% .25W CC TUBULAR	01121	C81005
A1R49	0683-2025		RESISTOR 2K 5% .25W CC TUBULAR	01121	C82025
A1R50	2100-3416	1	RESISTOR, VAR 250K OHM (INCLUDES S1A, B, C)	28480	2100-3416
A1R51	0683-5125	3	RESISTOR 5.1K 5% .25W CC TUBULAR	01121	C85125
A1R52	0683-5125		RESISTOR 5.1K 5% .25W CC TUBULAR	01121	C85125
A1R53	0683-5125		RESISTOR 5.1K 5% .25W CC TUBULAR	01121	C85125
A1R54	0683-1025	1	RESISTOR 1K 5% .25W CC TUBULAR	01121	C81025
A1R55	2100-1738		RESISTOR: VAR: TRMR: 10K OHM 10% C	19701	ET50W103
A1R56	-----		NOT ASSIGNED		
A1S1	-----		PART OF A1R50: NSR		
A1S2	3101-0684	1	SWITCH; SL; DPDT NS; 1A 125VAC	28480	3101-0684
A1T1	9100-3012	1	TRANSFORMER: DRIVER	28480	9100-3012
A1T2	9100-3011	1	TRANSFORMER	28480	9100-3011
A1U1	1820-0634	1	IC DGTL COUNTER	28480	1820-0634
A1U2	1920-0633	1	IC 4-D.S. TIME BASE	28480	1820-0633
A1U3	1820-1166	1	IC DGTL DM85L 51N FLIP-FLOP	27014	DM85L51N
A1U4	1820-0806	1	IC DGTL MC10109L GATE	06713	MC10109P
A1U5	1816-0412	1	IC DGTL MEMORY	28480	1816-0412
A1U6	1820-1251	1	IC DGTL SN74LS196 N COUNTER	01295	SN74LS196N
A1U7	1820-0214	1	IC DGTL SN74 42 N DECODER	01295	SN7442N
A1U8	1820-0099	1	IC DGTL SN74 93 N COUNTER	01295	SN7493N
A1U9	1820-0632 or 1820-1790	1	IC: LIS CONTROL	28480	1820-0632 or 1820-1790
A1U10	1820-0377	1	IC DGTL SN74H 50 N GATE	01295	SN74H50N
A1U11	1820-0370	1	IC DGTL SN74H 00 N GATE	01295	SN74H00N
A1U12	1820-1416	1	IC, TTL, SCHMITT, HEX INVERTER	01295	74LS14N
A1U13	1820-0658	1	IC DGTL MULTIPLEXER	07263	93L120C
A1U14	1820-1037	1	IC DGTL SN74 46AN DECODER	01295	SN7446AN
A1U15	1820-0585	1	IC DGTL DM74L 03N GATE	27014	DM74L03N
A1XA2	1251-3506	1	CONNECTOR; 12-CONT; FEM; POST TYPE	28480	1251-3506
A1XU5	1200-0473	1	SOCKET; ELEC; IC 16-CONT DIP SLDG TERM	28480	1200-0473
A1XU9	1200-0525	1	SOCKET; ELEC; IC 20-CONT DBL STRP PKG	00779	583640-2
A1Y1	0410-0423	1	CRYSTAL: QUARTZ	28480	0410-0423

See introduction to this section for ordering information

Table 6-1A. 5300B Standard Instrument, Replaceable Parts (Cont'd)

Reference Designation	HP Part Number	Qty	Description	Mfr Code	Mfr Part Number
A1A1 A1A1DS1-A1A1DS8	05300-60018 1990-0469 1990-0470 1990-0471	1 8 8 8	BOARD ASSY, DISPLAY LED (C) OR LED (D) OR LED (E) THREE BRIGHTNESS LEVELS ARE AVAILABLE; ORDER SAME NO. AS ORIGINAL. IF LED IS MARKED WITH PART NO. 5082-7731, A SINGLE LETTER CODE (C, D, OR E) IS STAMPED BE- NEATH THE PART NUMBER. THESE LETTER CODES ARE LISTED ABOVE IN THE DESCRIP- TION COLUMN; ORDER THE CORRESPONDING PART NO. LISTED ABOVE.	28480 28480 28480 28480	05300-60018 1990-0469 1990-0470 1990-0471
A1A1DS9 A1A1DS10 A1A1DS11	1990-0325 1990-0325 1990-0325	6	LED-VISIBLE LED-VISIBLE LED-VISIBLE	28480 28480 28480	1990-0325 1990-0325 1990-0325
A1A1DS12 A1A1DS13 A1A1DS14	1990-0325 1990-0325 1990-0325		LED-VISIBLE LED-VISIBLE LED-VISIBLE	28480 28480 28480	1990-0325 1990-0325 1990-0325
A1A1E1- A1A1E33	05300-20007	1	PINS, CONNECTOR (STRIP OF 33)	28480	05300-20007
A1A1R1 A1A1R2	0683-3305 0683-3305		RESISTOR 33 OHM 5% .25W CC TUBULAR RESISTOR 33 OHM 5% .25W CC TUBULAR	01121 01121	CB3305 CB3305
A1A1XDS1 A1A1XDS2 A1A1XDS3 A1A1XDS4 A1A1XDS5	1200-0424 1200-0424 1200-0424 1200-0424 1200-0424	8	SOCKET:IC BLK 14 CONTACT SOCKET:IC BLK 14 CONTACT SOCKET:IC BLK 14 CONTACT SOCKET:IC BLK 14 CONTACT SOCKET:IC BLK 14 CONTACT	23880 23880 23880 23880 23880	CSA2900-143 CSA2900-143 CSA2900-143 CSA2900-143 CSA2900-143
A1A1XDS6 A1A1XDS7 A1A1XDS8	1200-0424 1200-0424 1200-0424		SOCKET:IC BLK 14 CONTACT SOCKET:IC BLK 14 CONTACT SOCKET:IC BLK 14 CONTACT	23880 23880 23880	CSA2900-143 CSA2900-143 CSA2900-143
A2	05300-60019	1	BOARD ASSY, POWER SUPPLY	28480	05300-60019
A2C1 A2C2 A2C3 A2C4 A2C5	0160-0155 0160-0299 0140-0149 0160-0180 0180-2355	1 1 1 1 1	CAPACITOR-FXD 3300PF +-10% 200WVDC POLYE CAPACITOR-FXD 1800PF +-10% 200WVDC POLYE CAPACITOR-FXD 470PF +-5% 300WVDC MICA CAPACITOR-FXD .033UF +-5% 200WVDC POLYE CAPACITOR-FXD: 7.5UF+-5% 20VDC TA-SOL10	56289 56289 72136 56289 56289	292P33292 292P19292 DM15F471J0300WVLCR 292P33352 150D755X5020A2
A2CR1 A2CR2 A2CR3 A2CR4 A2CR5	1901-0040 1901-0040 1901-0050 1902-0689 1902-3110	2 2 2 1 2	DIODE-SWITCHING 2NS 30V 50MA DIODE-SWITCHING 2NS 30V 50MA DIODE-SWITCHING 2NS 80V 200MA DIODE BREAKDOWN DIODE-ZNR 5.9V 2% 00-7 PD=.4W TC=+.017%	28480 28480 28480 28480 04713	1901-0040 1901-0040 1901-0050 1902-0639 SZ 10939-117
A2CR6 A2CR7 A2CR8	1902-3110 1902-0556 1902-0556	2	DIODE-ZNR 5.9V 2% 00-7 PD=.4W TC=+.017% DIODE; ZENER; 20V VZ; 1W MAX PD DIODE; ZENER; 20V VZ; 1W MAX PD	04713 04713 04713	SZ 10939-117 SZ 11213-227 SZ 11213-227
A2E1- A2E12	1251-3788	12	"F" POST-ZIP STP	00779	1-380953-0
A2Q1 A2Q2 A2Q3 A2Q4 A2Q5	1853-0020 1854-0023 1855-0367 1853-0086 1853-0086	1 1 1 2 2	TRANSISTOR PNP SI CHIP PD=300MW TRANSISTOR NPN SI TO-18 PD=360MW TRANSISTOR; UNIJUNCTION; P ON N TRANSISTOR PNP SI CHIP PD=310MW TRANSISTOR PNP SI CHIP PD=310MW	28480 28480 28480 28480 28480	1853-0020 1854-0023 1855-0357 1853-0086 1853-0086
A2R1 A2R2 A2R3 A2R4 A2R5	0683-1535 0683-1535 0683-2025 0683-2015 0683-0085	2 2 2 2 1	RESISTOR 15K 5% .25W CC TUBULAR RESISTOR 15K 5% .25W CC TUBULAR RESISTOR 2K 5% .25W CC TUBULAR RESISTOR 200 OHM 5% .25W CC TUBULAR RESISTOR 2.61K 1% .125W F TUBULAR	01121 01121 01121 01121 16299	CB1535 CB1535 CB2025 CB2015 C4-1/8-T0-2511-F
A2R6 A2R7 A2R8 A2R9 A2R10	0683-7505 0757-0444 0757-0420 0683-3605 0683-5635	1 1 2 1 1	RESISTOR 75 OHM 5% .25W CC TUBULAR RESISTOR 12.1K 1% .125W F TUBULAR RESISTOR 750 OHM 1% .125W F TUBULAR RESISTOR 36 OHM 5% .25W CC TUBULAR RESISTOR 56K 5% .25W CC TUBULAR	01121 24546 24546 01121 01121	CB7505 C4-1/8-T0-1212-F C4-1/8-T0-751-F CB3605 CB5635
A2R11 A2R12 A2R13 A2R14	0698-3456 0757-0420 0698-3515 0683-1015	1 1 1 1	RESISTOR 287K 1% .125W F TUBULAR RESISTOR 750 OHM 1% .125W F TUBULAR RESISTOR 5.9K 1% .125W F TUBULAR RESISTOR 100 OHM 5% .25W CC TUBULAR	16299 24546 16299 01121	C4-1/8-T0-2873-F C4-1/8-T0-751-F C4-1/8-T0-5901-F CB1015
CHASSIS PARTS					
C1 C2	0160-3333 0160-3333	2	CAPACITOR-FXD 5000PF +-20% 250WVAC CER CAPACITOR-FXD 5000PF +-20% 250WVAC CER	28480 28480	0160-3333 0160-3333
F1	2110-0044	1	FUSE .3A 250V SLO-BLO OK	75915	313.2505
F1	2110-0320	1	FUSE .15A 250V SLO-BLO	71400	MDL 15/100

See introduction to this section for ordering information

Models 5300B and 5310A  
Replaceable Parts

Table 6-1A. 5300B Standard Instrument, Replaceable Parts (Cont'd)

Reference Designation	HP Part Number	Qty	Description	Mfr Code	Mfr Part Number
J1	1251-3546	1	CONNECTOR, AC POWER, FLANGED MALE RECPT	00180	6062-3
J2	1250-0083	1	CONNECTOR-COAX; BNC; 50 OHM FEMALE	24931	28JR-130-1
L1	9140-0098	2	COIL; FXD; MOLDED RF CHOKE; 2.2UH 10%	24226	15/221
L2	9140-0098		COIL; FXD; MOLDED RF CHOKE; 2.2UH 10%	24226	15/221
MP1	05300-80002	1	MASK, ANNUNCIATOR, UPPER	28480	05300-80002
MP2	5040-6000	1	CATCH, SLIDE LEFT HAND	28480	5040-6000
MP3	05300-00005	1	PANEL, REAR	28480	05300-00005
MP4	05300-40007	1	WINDOW	28480	05300-40007
MP5	05300-20010	1	CASE	28480	05300-20010
MP6	05300-40002	2	BLOCK, ANNUNCIATOR	28480	05300-40002
MP7	05300-40003	4	SUPPORT, BOARD	28480	05300-40003
MP8	05300-40004	4	GUIDE, SLIDE	28480	05300-40004
MP9	5040-7001	1	CATCH, SLIDE RIGHT HAND	28480	5040-7001
MP10	05300-80003	1	MASK, ANNUNCIATOR, LOWER	28480	05300-80003
MP11	7120-4250	1	LABEL-FRONT PANEL IDENTIFICATION	28480	9120-4250
Q17	1854-0487	1	TRANSISTOR, SI: NPN	28480	1854-0487
FOR Q17	0340-0765		INSULATOR, TRANSISTOR	28480	0340-0765
S1	3101-1234	1	SWITCH; SL; DPDT NS; 6A 250VAC	82389	11A-1242A
T1	9100-3013		TRANSFORMER: POWER	28480	9100-3013
			MISCELLANEOUS PARTS		
	0370-2632	1	KNOB	28480	0370-2632
	0590-0127	2	NUT-SHEETMETAL-U 4-40 THD .25-WD STL	78553	0991-440-24
	2110-0464	1	FUSEHOLDER; EXTR POST; BAY CAP; 20A	75915	345002-010
	2110-0465	1	FUSEHOLDER, CAP- FOR 3-AG FUSES	75915	345002-020
	2950-0054	1	NUT-HEX-DBL CHAM 1/2-28-THD .125-THK	28480	2950-0054
	8120-1378	1	CORD SET 3-COND 18AWG GRAY	28480	8120-1378
	05300-00006	2	CLIP; RFI	28480	05300-00006
	05300-80004	1	COVER, PROTECT	28480	05300-80015

See introduction to this section for ordering information

Table 6-1B. 5300B Option 001, Replaceable Parts

Reference Designation	HP Part Number	Qty	Description	Mfr Code	Mfr Part Number
OPTION 001					
A1	05300-60020	1	BOARD ASSY, LOGIC (SERIES 1704)	28480	05300-60020
A1C1	0180-0229	1	CAPACITOR-FXD: 33UF+-10% 10VDC TA-SOLID	56289	1500336X901082
A1C2	0150-0050	1	CAPACITOR-FXD 1000PF +80-20% 1000WVDC	28480	0150-0050
A1C3	0150-0071	2	CAPACITOR-FXD 400PF +-5% 1000WVDC CER	28480	0150-0071
A1C4	0150-0075	2	CAPACITOR-FXD 4700PF +100-20% 500WVDC	28480	0150-0075
A1C5	0150-0075		CAPACITOR-FXD 4700PF +100-20% 500WVDC	28480	0150-0075
A1C6	0180-2357	1	C:FXD TA 950 UF 90VDCW	28480	0180-2357
A1C7			NOT ASSIGNED		
A1C8			NOT ASSIGNED		
A1C9	0150-0096	1	CAPACITOR-FXD .05UF +80-20% 100WVDC CER	28480	0150-0096
A1C10			NOT ASSIGNED		
A1C11			NOT ASSIGNED		
A1C12			NOT ASSIGNED		
A1C13	0160-3879	1	CAPACITOR-FXD .01UF +-20% 100WVDC CER	28480	0160-3879
A1C14	0150-0071		CAPACITOR-FXD 400PF +-5% 1000WVDC CER	28480	0150-0071
A1C15	0160-2055	1	CAPACITOR-FXD .01UF +80-20% 100WVDC CER	28480	0160-2055
A1C16	0180-1743	1	CAPACITOR-FXD: .1UF+-10% 35VDC TA-SOLID	56289	1500104X9035A2
A1C17	0180-0428	3	CAPACITOR-FXD: 68UF+-20% 6VDC TA-SOLID	28480	0180-0428
A1C18	0180-0557	2	CAPACITOR-FXD 150UF +100-10% 6VDC AL	90201	MTV150C06
A1C19	0180-0554	1	CAPACITOR-FXD: 150UF+-20% 6VDC TA-SOLID	28480	0180-0554
A1C20	0180-0551	2	CAPACITOR-FXD 35UF +100-10% 25VDC AL	90201	MTV35C825
A1C21	0180-0551		CAPACITOR-FXD 35UF +100-10% 25VDC AL	90201	MTV35C825
A1C22	0180-0557		CAPACITOR-FXD 150UF +100-10% 6VDC AL	90201	MTV150C06
A1C23	0180-0373	1	*CAPACITOR-FXD: 68UF+-10% 35VDC TA	56289	1500684X9035A2
A1C24	0180-0552	2	CAPACITOR-FXD: 220UF+-20% 10VDC TA	28480	0180-0552
A1C25	0180-0552		CAPACITOR-FXD: 220UF+-20% 10VDC TA	28480	0180-0552
A1C26	0180-0428		CAPACITOR-FXD: 68UF+-20% 6VDC TA-SOLID	28480	0180-0428
A1C27	0180-0553	2	CAPACITOR-FXD: 22UF+-20% 25VDC TA-SOLID	28480	0180-0553
A1C28	0180-0553		CAPACITOR-FXD: 22UF+-20% 25VDC TA-SOLID	28480	0180-0553
A1C29	0180-0161	1	CAPACITOR-FXD: 3.3UF+-20% 35VDC TA	56289	1500335X003582
A1C30	0160-2204	1	CAPACITOR-FXD 100PF +-5% 300WVDC MICA	28480	0160-2204
A1C31	0180-0428		CAPACITOR-FXD: 68UF+-20% 6VDC TA-SOLID	28480	0180-0428
A1CR1	1901-0028	7	DIODE-PWR RECT 400V 750MA	04713	SR1358-9
A1CR2	1901-1081	2	DIODE-PWR RECT 100V 3A	28480	1901-1081
A1CR3	1901-0028		DIODE-PWR RECT 400V 750MA	04713	SR1358-9
A1CR4	1901-1081		DIODE-PWR RECT 100V 3A	28480	1901-1081
A1CR5	1901-0028		DIODE-PWR RECT 400V 750MA	04713	SR1358-9
A1CR6	1901-0028		DIODE-PWR RECT 400V 750MA	04713	SR1358-9
A1CR7	1901-0028		DIODE-PWR RECT 400V 750MA	04713	SR1358-9
A1CR8	1902-3205	1	DIODE-ZNR 15V 5% DO-7 PD=-.4W TC=+.057%	04713	SZ 10939-233
A1CR9	1901-0050	1	DIODE-SWITCHING 2N5 80V 200MA	28480	1901-0050
A1CR10	1902-3381	1	DIODE-ZNR 68.1V 5% DO-7 PD=-.4W	04713	SZ 10939-422
A1CR11	1901-0028		DIODE-PWR RECT 400V 750MA	04713	SR1358-9
A1CR12	1901-0028		DIODE-PWR RECT 400V 750MA	04713	SR1358-9
A1J1	1251-2564	1	CONNECTOR, 50-CONT, MALE, MICRO RIBBON	71785	57-10500-27
FOR A1J1	0905-0479	1	GASKET, TEFLON	28480	0905-0479
A1L1	9100-3139	5	COIL:75 UH	28480	9100-3139
A1L2	9100-3139		COIL:75 UH	28480	9100-3139
A1L3	9100-3139		COIL:75 UH	28480	9100-3139
A1L4	9100-3139		COIL:75 UH	28480	9100-3139
A1L5	9100-3139		COIL:75 UH	28480	9100-3139
A1L6	9140-0210	2	COIL: FXD; MOLDED RF CHOKE; 100UH 5%	24226	15/103
A1L7	9140-0210		COIL: FXD; MOLDED RF CHOKE; 100UH 5%	24226	15/103
A1Q1	1854-0215	2	TRANSISTOR NPN SI PD=310MW FT=300MHZ	04713	SPS 3611
A1Q2	1853-0318	8	TRANSISTOR PNP SI CHIP PD=500MW	28480	1853-0318
A1Q3	1853-0318		TRANSISTOR PNP SI CHIP PD=500MW	28480	1853-0318
A1Q4	1853-0318		TRANSISTOR PNP SI CHIP PD=500MW	28480	1853-0318
A1Q5	1853-0318		TRANSISTOR PNP SI CHIP PD=500MW	28480	1853-0318
A1Q6	1853-0318		TRANSISTOR PNP SI CHIP PD=500MW	28480	1853-0318
A1Q7	1853-0318		TRANSISTOR PNP SI CHIP PD=500MW	28480	1853-0318
A1Q8	1853-0318		TRANSISTOR PNP SI CHIP PD=500MW	28480	1853-0318
A1Q9	1853-0318		TRANSISTOR PNP SI CHIP PD=500MW	28480	1853-0318
A1Q10			NOT ASSIGNED		
A1Q11			NOT ASSIGNED		
A1Q12	1853-0036	3	TRANSISTOR PNP SI CHIP PD=310MW	28480	1853-0036
A1Q13	1853-0036		TRANSISTOR PNP SI CHIP PD=310MW	28480	1853-0036
A1Q14	1853-0036		TRANSISTOR PNP SI CHIP PD=310MW	28480	1853-0036
A1Q15	1854-0215		TRANSISTOR NPN SI PD=310MW FT=300MHZ	04713	SPS 3611

\*FACTORY SELECTED VALUE

See introduction to this section for ordering information

Models 5300B and 5310A  
Replaceable Parts

Table 6-1B. 5300B Option 001, Replaceable Parts (Cont'd)

Reference Designation	HP Part Number	Qty	Description	Mfr Code	Mfr Part Number
A1Q16	1854-0492	1	TRANSISTOR NPN SI PD=350MW FT=250MHZ	28480	1854-0492
A1P1	0683-2025	3	RESISTOR 2K 5% .25W CC TUBULAR	01121	CR2025
A1R2	0683-6215	2	RESISTOR 620 OHM 5% .25W CC TUBULAR	01121	CB6215
A1R3	0683-3915	1	RESISTOR 390 OHM 5% .25W CC TUBULAR	01121	CB3915
A1R4	0683-1035	4	RESISTOR 10K 5% .25W CC TUBULAR	01121	CB1035
A1R5	1810-0055	2	NETWORK-RES 9-PIN SIP .15-PIN-SPCG	28480	1810-0055
A1R6	0683-1035		RESISTOR 10K 5% .25W CC TUBULAR	01121	CB1035
A1R7	0683-1035		RESISTOR 10K 5% .25W CC TUBULAR	01121	CB1035
A1R8	0683-1055	1	RESISTOR 1M 5% .25W CC TUBULAR	01121	CB1055
A1R9			NOT ASSIGNED		
A1R10			NOT ASSIGNED		
A1R11			NOT ASSIGNED		
A1R12			NOT ASSIGNED		
A1R13	0683-1525	1	RESISTOR 1.5K 5% .25W CC TUBULAR	01121	CB1525
A1R14	0683-1035		RESISTOR 10K 5% .25W CC TUBULAR	01121	CB1035
A1R15	1810-0055		NETWORK-RES 9-PIN SIP .15-PIN-SPCG	28490	1810-0055
A1R16	0683-7515	2	RESISTOR 750 OHM 5% .25W CC TUBULAR	01121	CB7515
A1P17	0683-2015	8	RESISTOR 200 OHM 5% .25W CC TUBULAR	01121	CR2015
A1R18	0683-2015		RESISTOR 200 OHM 5% .25W CC TUBULAR	01121	CB2015
A1P19	0683-2015		RESISTOR 200 OHM 5% .25W CC TUBULAR	01121	CB2015
A1R20	0683-2015		RESISTOR 200 OHM 5% .25W CC TUBULAR	01121	CB2015
A1R21	0683-7515		RESISTOR 750 OHM 5% .25W CC TUBULAR	01121	CB7515
A1R22			NOT ASSIGNED		
A1P23			NOT ASSIGNED		
A1R24			NOT ASSIGNED		
A1R25			NOT ASSIGNED		
A1P26			NOT ASSIGNED		
A1R27	0683-8215		RESISTOR 820 OHM 5% .25W CC TUBULAR	01121	CB8215
A1R28			NOT ASSIGNED		
A1R29			NOT ASSIGNED		
A1K30	0683-2015		RESISTOR 200 OHM 5% .25W CC TUBULAR	01121	CB2015
A1P31	0683-2015		RESISTOR 200 OHM 5% .25W CC TUBULAR	01121	CB2015
A1R32	0683-2015		RESISTOR 200 OHM 5% .25W CC TUBULAR	01121	CB2015
A1R33	0683-2015		RESISTOR 200 OHM 5% .25W CC TUBULAR	01121	CB2015
A1R34	0683-1025	3	RESISTOR 1K 5% .25W CC TUBULAR	01121	CB1025
A1R35	0683-2035	1	RESISTOR 20K 5% .25W CC TUBULAR	01121	CB2035
A1R36	0683-1015	2	RESISTOR 100 OHM 5% .25W CC TUBULAR	01121	CB1015
A1P37	0683-2025		RESISTOR 2K 5% .25W CC TUBULAR	01121	CR2025
A1R38	0683-1025		RESISTOR 1K 5% .25W CC TUBULAR	01121	CB1025
A1P39	0683-2715	1	RESISTOR 270 OHM 5% .25W CC TUBULAR	01121	CB2715
A1P40	0683-1505	1	RESISTOR 15 OHM 5% .25W CC TUBULAR	01121	CB1505
A1R41	0683-3305	7	RESISTOR 33 OHM 5% .25W CC TUBULAR	01121	CB3305
A1R42	0683-3305		RESISTOR 33 OHM 5% .25W CC TUBULAR	01121	CB3305
A1P43	0683-3305		RESISTOR 33 OHM 5% .25W CC TUBULAR	01121	CB3305
A1P44	0683-3305		RESISTOR 33 OHM 5% .25W CC TUBULAR	01121	CB3305
A1R45	0683-3305		RESISTOR 33 OHM 5% .25W CC TUBULAR	01121	CB3305
A1R46	0683-3305		RESISTOR 33 OHM 5% .25W CC TUBULAR	01121	CB3305
A1P47	0683-3305		RESISTOR 33 OHM 5% .25W CC TUBULAR	01121	CB3305
A1R48	0683-1005	1	RESISTOR 10 OHM 5% .25W CC TUBULAR	01121	CB1005
A1P49	0683-2025		RESISTOR 2K 5% .25W CC TUBULAR	01121	CB2025
A1R50	2100-3416	1	RESISTOR, VAR 250K OHM (INCLUDES S1A, B, C)	28480	2100-3416
A1R51	0683-5125	3	RESISTOR 5.1K 5% .25W CC TUBULAR	01121	CB5125
A1R52	0683-5125		RESISTOR 5.1K 5% .25W CC TUBULAR	01121	CB5125
A1R53	0683-5125		RESISTOR 5.1K 5% .25W CC TUBULAR	01121	CB5125
A1P54	0683-1025		RESISTOR 1K 5% .25W CC TUBULAR	01121	CB1025
A1R55	2100-1738	1	RESISTOR, VAR; TRMR; 10KOHM 10% C	19701	ET50M103
A1R56	0683-1015		RESISTOR; 100 OHM 5% .25W CC TUBULAR	01121	CB1015
A1S1			PART OF A1R50: NSR		
A1S2	3101-0684	1	SWITCH; SL; OPDT NS; 1A 125VAC	28480	3101-0684
A1T1	9100-3012	1	TRANSFORMER; DPIVER	28480	9100-3012
A1T2	9100-3011	1	TRANSFORMER	28480	9100-3011
A1U1	1820-0634	1	IC DGTL COUNTER	28480	1820-0634
A1U2	1820-0633	1	IC:M.O.S. TIME BASE	28480	1820-0633
A1U3	1820-1166	1	IC DGTL DMR5L 51N FLIP-FLOP	27014	DMR5L51N
A1U4			NOT ASSIGNED		
A1U5	1816-0412	1	IC DGTL MEMORY	28480	1816-0412
A1U6	1820-1251	1	IC DGTL SN74LS196 N COUNTER	01295	SN74LS196N
A1U7	1820-0214	1	IC DGTL SN74 42 N DECODER	01295	SN7442N
A1U8	1820-0099	1	IC DGTL SN74 93 N COUNTER	01295	SN7493N
A1U9	1820-0632 or 1820-1790	1	IC:LSI CONTROL	28480	1820-0632 or 1820-1790
A1U10	1820-0377	1	IC DGTL SN74H 50 N GATE	01295	SN74H50N
A1U11	1820-0370	1	IC DGTL SN74H 00 N GATE	01295	SN74H00N
A1U12	1820-1416	1	IC TTL SCHMITT, HEX INVERTER	01295	74LS14N
A1U13	1820-0658	1	IC DGTL MULTIPLEXER	07263	93L12NC
A1U14	1820-1037	1	IC DGTL SN74 46AN DECODER	01295	SN7446AN
A1U15	1820-0585	1	IC DGTL DM74L 03N GATE	27014	DM74L03N
A1U16	0960-0318	1	CRYSTAL OSCILLATOR	28480	0960-0318
A1X42	1251-3506	1	CONNECTOR; 12-CONT; FEM; POST TYPE	28480	1251-3506
A1XU5	1200-0473	1	SOCKET; ELEC; IC 16-CONT DIP SLDR TERM	28480	1200-0473
A1XU9	1200-0525	1	SOCKET; ELEC; IC 20-CONT DBL STRP PKG	00779	583640-2

■ NOT USED IN SERIES 1452A INSTRUMENTS  
WITH OPTION 001.

See introduction to this section for ordering information

Table 6-2. Replaceable Parts for 5310A

Reference Designation	HP Part Number	Qty	Description	Mfr Code	Mfr Part Number
A1	05310-60002	1	BOARD ASSY:INTERCONNECT	28480	05310-60002
A1J1	1251-0099	1	CONNECTOR:R & P 50 CONTACT (MALE, BOTTOM)	0266C	57-10500-375
A1P1	1251-0101	1	CONNECTOR:R & P 50 CONTACT (FEMALE, TOP)	0266C	57-20500-375
A2	05310-60001	1	BOARD ASSY:POWER SUPPLY	2848C	05310-60001
A2C2	0180-2373	2	C:FXD AL ELECT 580 UF +150-10% 35VDCW	90201	TT581H035P3E1N
A2CP1	1901-0028	2	DIODE:SILICON 0.75A 400PIV	04713	SR1358-9
A2CR2	1902-0693	1	DIODE BREAKDOWN	28480	1902-0693
A2CR3	1901-0044	1	DIODE:SILICON 20MA/1V	28480	1901-0044
A2CR4	1901-0028	1	DIODE:SILICON 0.75A 400PIV	04713	SR1358-9
A2DS1	1990-0325	1	DIODE:VISIBLE LIGHT EMITTER (L.E.D.)	2848C	1990-0325
A2F1	2110-0332	1	FUSE:3A	71400	GMW 3
A2J1	1251-1636	2	CONNECTOR:SINGLE MALE CONTACT	2848C	1251-1636
A2J2	1251-1636	2	CONNECTOR:SINGLE MALE CONTACT	2848C	1251-1636
A2Q1	1853-0086	3	TSTR:SI PNP	80131	2N5087
A2Q2	1853-0086	3	TSTR:SI PNP	80131	2N5087
A2Q4	1853-0086	3	TSTR:SI PNP	80131	2N5087
A2R1	0683-2745	1	R:FXD COMP 270K OHM 5% 1/4W	01121	CB 2745
A2R2	0813-0034	1	R:FXD WW 1.8 OHM 3% 1W	2848C	0813-0034
A2R3	0683-3935	1	R:FXD COMP 39K OHM 5% 1/4W	01121	CB 3935
A2K4	0761-0015	1	R:FXD MET OX 1500 OHM 5% 1W	28480	0761-0015
A2R5	0683-3315	1	R:FXD COMP 330 OHM 5% 1/4W	01121	CB 3315
A2R6	0698-3547	1	R:FXD COMP 1 OHM 5% 1/2W	01121	EB 1065
A2R7	0683-5115	1	R:FXD COMP 510 OHM 5% 1/4W	01121	CB 5115
A2R8	0683-2615	1	R:FXD COMP 200 OHM 5% 1/4W	01121	CB 2015
A2R8	0550-0051	2	SCREW:PAN HD POZI DR 3-48 X 0.375" LG	0000C	080
A2R8	220C-0103	14	SCREW:SST PHH POZI DR 4-40 X 1/4"W/LK	0000C	080
A2R8	220C-0107	5	SCREW:POZI DR 4-40 X 3/8 W/LOCK	0000C	080
A2R8	220C-0164	12	SCREW:FLAT HD POZI 4-40 X 3/16	0000C	080
A2R8	2360-0113	3	SCREW:PAN HD POZI 6-32 X 1/4 W/LK	0000C	080
A2R8	2360-0117	6	SCREW:PAN HD POZI 6-32 X 3/8 W/LK	0000C	080
A2S1	3101-0543	1	SWITCH:SLIDE DP3T MINIATURE	7848E	SS-93
CHASSIS AND MISCELLANEOUS PARTS					
BT1	1420-0084 OR 1420-0209	5 5	BATTERY:2.50V BATTERY:2.50V	05397 28480	Y5916 1420-0209
MP1	1440-0075	1	CARRY STRAP	28480	1440-0075
MP2	1440-0096	1	HANDLE:STRAP	2848C	1440-0096
MP3	1440-0097	1	HANDLE:SHOULDER	28480	1440-0097
MP4	5040-6000	2	CATCH:LEFT SIDE	2848C	5040-6000
MP4	05300-80004	2	COVER:PLASTIC PROTECTIVE	2848C	05300-80004
MP5	5040-7001	2	CATCH:RIGHT SIDE	2848C	5040-7001
MP6	05310-00001	1	PANEL:FRONT	28480	05310-00001
MP7	05310-00002	1	PANEL:REAR	28480	05310-00002
MP8	05310-00011	1	PANEL:SUB	2848C	05310-00011
MP9	05310-00004	1	BRACKET:LEFT	2848C	05310-00004
MP10	05310-00005	1	CASE:BATTERY	28480	05310-00005
MP11	05310-00006	1	HOLDER:BATTERY	28480	05310-00006
MP12	05310-00007	1	COVER:BATTERY	28480	05310-00007
MP13	05310-00008	1	BRACKET:RIGHT	28480	05310-00008
MP14	05310-40001	4	GUIDE:SLIDE	28480	05310-40001
MP15	05310-20005	2	FRAME:SIDE	2848C	05310-20005
MP16	0340-0765	1	INSULATOR:TRANSISTOR	C1295	A-0340-0765-1
MP17	1400-0808	1	MOUNTING CLIP	28480	1400-0808
MP18	3050-0791	1	WASHER:SHOULDER 0.115" ID, NYLON	28480	3050-0791
MP19	05310-00012	1	PANEL:SUB	2848C	05310-00012
MP20	1460-1312	1	SPRING:LEAF	28480	1460-1312
Q3	1854-0420	1	TSTR:SI NPN	28480	1854-0420
	1400-0665	1	CLIP, LED MTG	28480	1400-0665

See introduction to this section for ordering information

Table 6-3. Code List of Manufacturers

<b>Mfr. No.</b>	<b>Manufacturer Name, Address, and Zip Code</b>
00000	U.S.A. Common, Any Supplier of U.S.A.
00779	Amp Inc., (Aircraft Marine Prod.), Harrisburg, Pa. 17101
01121	Allen Bradley Co., Milwaukee, Wis. 53204
01295	Texas Instruments, Inc., Semiconductor Components Div., Dallas, Tex. 75231
02660	Amphenol Corp., Broadview, Ill. 60153
04713	Motorola Semiconductor Prod. Inc., Phoenix, Ariz. 85008
05397	Union Carbide Corp. Elect. Div., New York, N.Y. 10017
05574	Viking Ind. Inc., Chatsworth, Calif. 91311
05820	Wakefield Engineering Inc., Wakefield, Mass. 01880
07263	Fairchild Camera and Inst. Corp. Semiconductor Div., Mountain View, Ca. 94040
12040	National Semiconductor Corp., Danbury, Conn. 06810
16299	Corning GL WK Elec. Component Div., Raleigh, N.C. 27604
19701	Mepco/Electric Corp., Mineral Wells, Tex. 76067
23880	Stanford Applied Engrg., Santa Clara, Calif. 95050
24226	Gowanda Electronics Corp., Gowanda, N.Y. 14070
24546	Corning Glass Works, Bradford, Pa. 16701
24931	Specialty Connector Co. Inc., Indianapolis, In. 46227
27014	National Semiconductor Corp., Santa Clara, Ca 95051
28480	Hewlett-Packard Co., Corporate Hq., Your Nearest HP Office
56289	Sprague Electric Co., N. Adams, Mass. 01247
70903	Belden Corp., Chicago, Ill. 60644
70998	Bird Electronics Corp., Cleveland, Ohio 44139
71400	Bussmann Mfg. Div. McGraw-Edison Co., St. Louis, Mo. 63017
71616	Commercial Plastics Co., Mundelein, Ill. 60060
71785	Cinch Mfg. Co. Div. TRW Inc., Elk Grove Village, Ill.
72136	Electro Motive Mfg. Co. Inc., Willimantic, Conn. 06226
72982	Erie Technological Prod. Inc., Erie, Pa. 16512
73899	JFD Electronics Corp., Brooklyn, N.Y. 11219
74868	Amphenol Corp. RF Div., Danbury, Conn. 06810
75915	Littlefuse Inc., Des Plaines, Il. 60016
78488	Stackpole Carbon Co., St. Marys, Pa. 15857
78553	Tinnerman Products Inc., Cleveland, Oh. 44129
80131	Electronic Industries Association, Washington, D.C. 20006
82389	Switchcraft Inc., Chicago, Ill. 60630
90201	Mallory Capacitor Co., Indianapolis, Ind. 46206
96733	San Fernando Elect. Mfg. Co., San Fernando, Calif. 91341



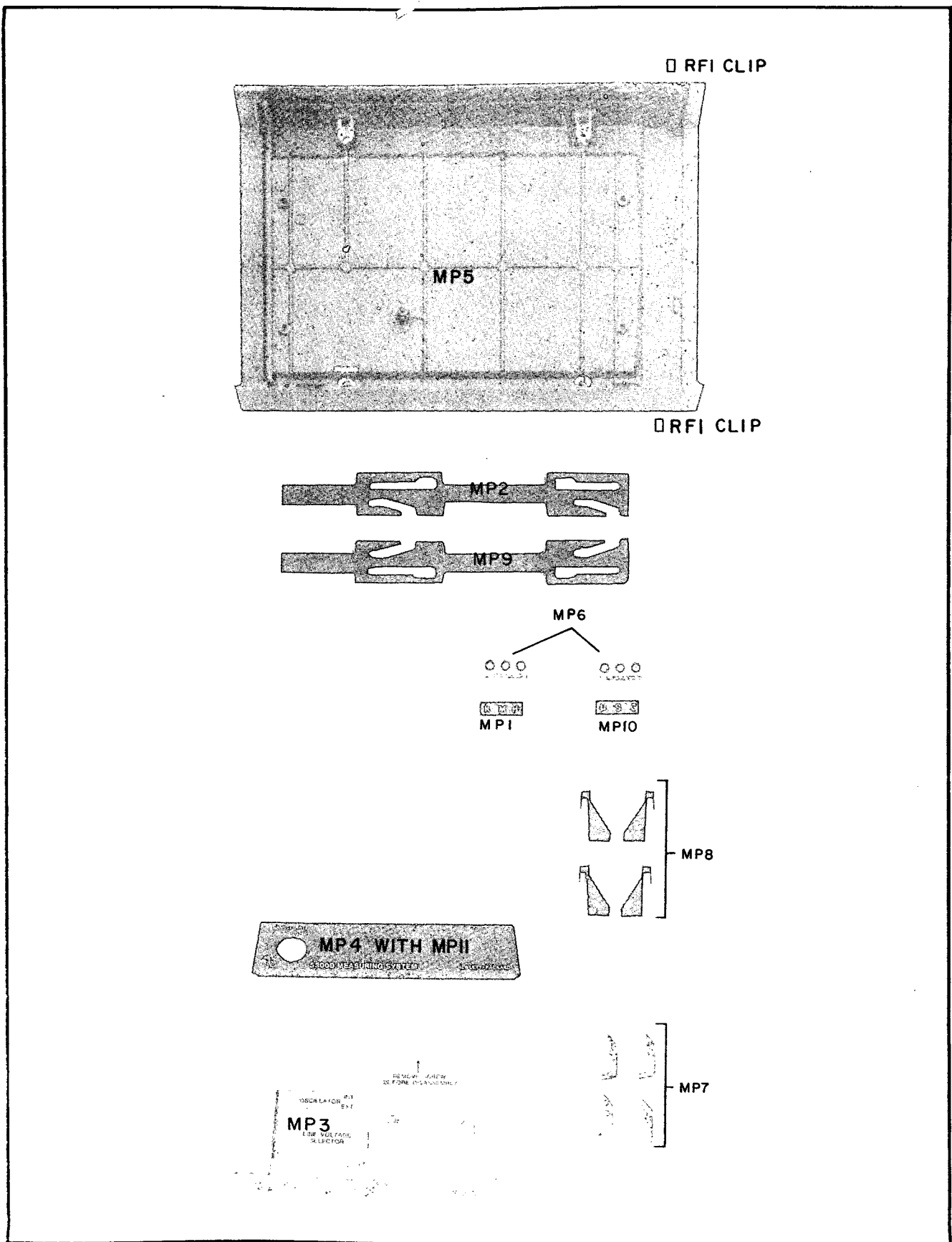

Figure 6-1. 5300B Mainframe Mechanical Parts

Models 5300B and 5310A  
Replaceable Parts

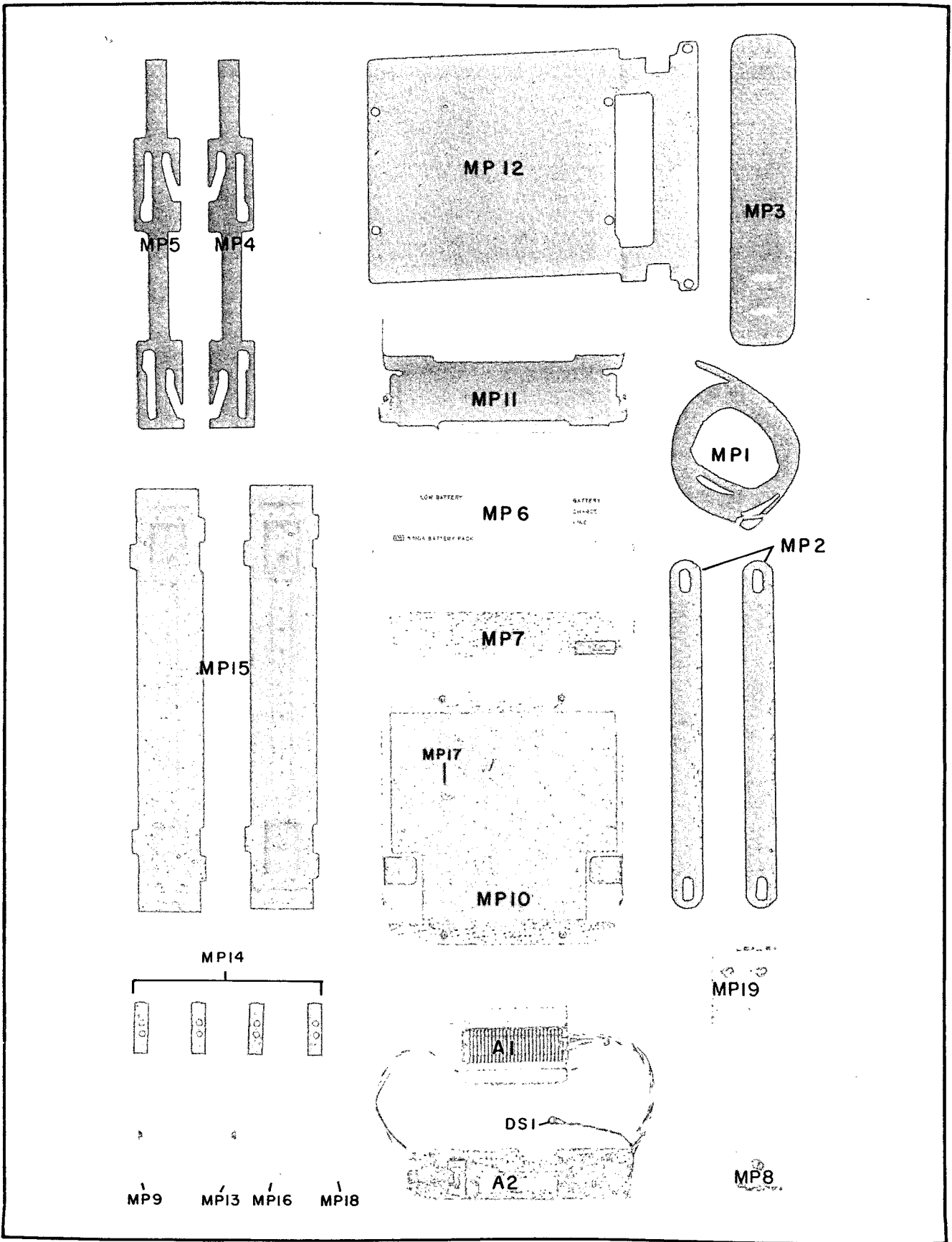

Figure 6-2. 5310A Battery Pack Mechanical Parts

## SECTION VII

### MANUAL CHANGES AND OPTIONS

#### 7-1. INTRODUCTION

7-2. This section contains information necessary to adapt this manual to apply to older instruments. Also included is information regarding available options.

#### 7-3. 5300A MEASURING SYSTEM

7-4. The 5300A Measuring System is completely described in a separate manual.

#### 7-5. OPTIONS

7-6. One option is available for the 5300B: Option 001 High Stability Time Base (temperature compensated crystal oscillator — TCXO). See Table 1-3 for specifications.

#### 7-7. FIELD INSTALLATION OF OPTION 001

7-8. Option 001, TCXO, field installation procedure is given in the following steps:

- a. Disconnect the power cable from the 5300B. (Safety precaution.)
- b. Refer to INSTRUMENT ACCESS paragraph in Section V and perform steps a through e-3.

**CAUTION**

Refer to the **MAINTENANCE AND REPAIR** paragraphs in Section V for instructions about component removal and replacement.

- c. Refer to Figure 7-1 or 8-4, depending upon instrument serial prefix number, and remove and install components indicated on figure.
- d. Reverse the procedure steps a and b to make the 5300B ready to be used after installation of the TCXO.

#### 7-9. MANUAL CHANGES

7-10. This manual applies directly to Model 5300B Measuring Systems with serial number prefix 1452A or 1636A and to Model 5310A Battery Packs with serial number prefix 1312A. For information about manual changes for newer or older units, refer to the following paragraphs.

#### 7-11. Newer Instruments

7-12. As engineering changes are made, newer instruments may have serial prefix numbers higher than

those listed on the title page of this manual. The manuals for these instruments will be supplied with "manual changes" sheets containing the required information. Replace affected pages or modify existing manual information as directed in the "manual changes" pages. Contact the nearest Hewlett-Packard Sales and Service Office if the change information is missing.

#### 7-13. Older Instruments (5310A Battery Packs)

7-14. The following paragraphs list the manual changes required to backdate this manual to cover Model 5310A Battery Packs with lower serial number prefixes than those listed on the title page of this manual. Make the manual changes given in the paragraph that corresponds to the serial number prefix of your instrument.

7-15. 5310A, serial prefix 1232A. On Page 6-7, Table 6-2, delete the entries for MP8 and MP19; add the following: "MP8 05310-00003, 1, PANEL:SUB, 28480, 05310-00003".

7-16. 5310A, serial prefix 1128A. Make the changes given in Paragraph 7-9. On these and older instruments two-piece catch-slides were used in place of the newer one-piece parts listed on Page 6-7, Table 6-2 (MP4 and MP5). The newer parts (part numbers 5040-6000 and 5040-7001) should be used, however, if replacement is required.

#### 7-17. Older Instruments (5300B)

7-18. Table 7-1 lists changes required to backdate this manual to cover Model 5300B's with lower serial number prefixes than those listed on the title page of this manual. Make the manual changes given in Table 7-1 that correspond to the serial prefix of your instrument.

Table 7-1. 5300B Backdating

If your 5300B has Serial Prefix	Make the following changes to your Manual
1420A or 1428A	1
1452A or 1636A	2 (See Note 7 on Figure 8-8)

Models 5300B and 5310A  
Manual Changes and Options

**CHANGE 1**

Replace Table 6-1A and B with Table 7-2.  
Replace Figure 8-4 with Figure 7-1.  
Replace Figure 8-6 with Figure 7-2.  
Replace Figure 8-7 with Figure 7-3.

**CHANGE 2**

Pages 6-3 and 6-7, Tables 6-1A and 6-1B,  
Replaceable Parts:

Change series number for A1 assemblies  
(05300-60017 and 05300-60020) to SERIES  
1524A or 1636A.

**CHANGE 2 (Cont'd)**

Pages 6-3 and 6-7, Tables 6-1A and 6-1B,  
Replaceable Parts (Cont'd):

Change A1R27 on both assemblies from  
0683-8215 (820 $\Omega$ ) to 0683-6215; RESISTOR  
620 OHM 5% .25W CC TUBULAR; 01121;  
CB6215.

Page 8-9, Figure 8-8, Schematic Diagram:

Change both series number for A1 (05300-  
60017 and 05300-60020) to "1452A or  
1636A".

Change A1R27 from 820 to 620 ohms.

Table 7-2. 5300B Replaceable Parts  
(A1 Series 1420A and 1428A)

Reference Designation	HP Part Number	Qty	Description	Mfr Code	Mfr Part Number
STANDARD OSCILLATOR					
A1	05300-60017	1	BOARD ASSY, LOGIC (SERIES 1420A OR 1428A)	28480	05300-60017
A1C1	0180-0229	1	CAPACITOR-FXD; 330F+-10% 10VDC TA-SOLID	56289	150D336X901082
A1C2	0150-0050	1	CAPACITOR-FXD 1000PF +80-20% 1000WVDC	28480	0150-0050
A1C3	0150-0071	2	CAPACITOR-FXD 400PF +-5% 1000WVDC CER	28480	0150-0071
A1C4	0150-0075	2	CAPACITOR-FXD 4700PF +100-20% 500WVDC	28480	0150-0075
A1C5	0150-0075		CAPACITOR-FXD 4700PF +100-20% 500WVDC	28480	0150-0075
A1C6	0180-2357	1	C:FXD TA 950 UF 90VDCW	28480	0180-2357
A1C7 ..	0160-2055	2	CAPACITOR-FXD.01 μF 100V	28480	0160-2055
A1C8 ..	0160-0161	1	CAPACITOR-FXD .01UF +-10% 200WVDC POLYE	56289	292P10392
A1C9	0150-0096	1	CAPACITOR-FXD .05UF +80-20% 100WVDC CER	28480	0150-0096
A1C10..	0121-0061	1	CAPACITOR; VAR; TRMR; CER; 5.5/18PF	28480	0121-0061
A1C11..	0121-0059	1	CAPACITOR; VAR; TRMR; CER; 2/8PF	73899	DV11PRBA
A1C12..	0160-2257		CAPACITOR-FXD 10PF +-5% 500WVDC CER	28480	0160-2257
A1C13	0160-3879	1	CAPACITOR-FXD .01UF +-20% 100WVDC CER	28480	0160-3879
A1C14	0150-0071		CAPACITOR-FXD 400PF +-5% 1000WVDC CER	28480	0150-0071
A1C15	0160-2055		CAPACITOR-FXD .01 μF 100V	28480	0160-2055
A1C16	0180-1773	1	CAPACITOR-FXD: .68UF +-5% 35VDC TA	56289	150D684X5035A2-DYS
A1C17	0180-0428	2	CAPACITOR-FXD: 6.8UF+-20% 6VDC TA-SOLID	28480	0180-0428
A1C18	0180-0557	2	CAPACITOR-FXD 150UF +100-10% 6VDC AL	90201	MTV150C06
A1C19	0180-0554	1	CAPACITOR-FXD: 1.50UF+-20% 6VDC TA-SOLID	28480	0180-0554
A1C20	0180-0551	2	CAPACITOR-FXD 35UF +100-10% 25VDC AL	90201	MTV35C825
A1C21	0180-0551		CAPACITOR-FXD 35UF +100-10% 25VDC AL	90201	MTV35C825
A1C22	0180-0557		CAPACITOR-FXD 150UF +100-10% 6VDC AL	90201	MTV150C06
A1C23	0180-0195	1	CAPACITOR-FXD: .33UF+-20% 35VDC TA	56289	150D334X0035A2
A1C24	0180-0552	2	CAPACITOR-FXD: 220UF+-20% 10VDC TA	28480	0180-0552
A1C25	0180-0552		CAPACITOR-FXD: 220UF+-20% 10VDC TA	28480	0180-0552
A1C26	0180-0428		CAPACITOR-FXD: 6.8UF+-20% 6VDC TA-SOLID	28480	0180-0428
A1C27	0180-0553	2	CAPACITOR-FXD: 2.2UF+-20% 25VDC TA-SOLID	28480	0180-0553
A1C28	0180-0553		CAPACITOR-FXD: 2.2UF+-20% 25VDC TA-SOLID	28480	0180-0553
A1C29	0180-0161	1	CAPACITOR-FXD: 3.3UF+-20% 35VDC TA	56289	150D335X0035B2
A1C30			NOT ASSIGNED		
A1CR1	1901-0028	7	DIODE-PWR RECT 400V 750MA	04713	SR1358-9
A1CR2	1901-1081	2	DIODE-PWR RECT 100V 3A	28480	1901-1081
A1CR3	1901-0028		DIODE-PWR RECT 400V 750MA	04713	SR1358-9
A1CR4	1901-1081		DIODE-PWR RECT 100V 3A	28480	1901-1081
A1CR5	1901-0028		DIODE-PWR RECT 400V 750MA	04713	SR1358-9
A1CR6	1901-0028		DIODE-PWR RECT 400V 750MA	04713	SR1358-9
A1CR7	1901-0028		DIODE-PWR RECT 400V 750MA	04713	SR1358-9
A1CR8	1902-3205	1	DIODE-ZNR 15V 5% DO-7 PD=.4W TC=+.05% DIODE-SWITCHING 2NS 80V 200MA	04713	SZ 10939-233
A1CR9	1901-0050	2	DIODE-SWITCHING 2NS 80V 200MA	28480	1901-0050
A1CR10	1902-3381	1	DIODE-ZNR 68.1V 5% DO-7 PD=.4W	04713	SZ 10939-422
A1CR11	1901-0028		DIODE-PWR RECT 400V 750MA	04713	SR1358-9
A1CR12	1901-0028		DIODE-PWR RECT 400V 750MA	04713	SR1358-9
A1CR13			NOT ASSIGNED		
A1J1	1251-2564	1	CONNECTOR, 50-CONT, MALE, MICRO RIBBON	71785	57-10500-27
A1L1	9100-3139	5	COIL:75 UH	28480	9100-3139
A1L2	9100-3139		COIL:75 UH	28480	9100-3139
A1L3	9100-3139		COIL:75 UH	28480	9100-3139
A1L4	9100-3139		COIL:75 UH	28480	9100-3139
A1L5	9100-3139		COIL:75 UH	28480	9100-3139
A1L6	9140-0210	1	COIL; FXD; MOLDED RF CHOKE; 100UH 5%	24226	15/103
A1Q1	1854-0215	2	TRANSISTOR NPN SI PD=310MW FT=300MHZ	04713	SPS 3611
A1Q2	1853-0318	8	TRANSISTOR PNP SI CHIP PD=500MW	28480	1853-0318
A1Q3	1853-0318		TRANSISTOR PNP SI CHIP PD=500MW	28480	1853-0318
A1Q4	1853-0318		TRANSISTOR PNP SI CHIP PD=500MW	28480	1853-0318
A1Q5	1853-0318		TRANSISTOR PNP SI CHIP PD=500MW	28480	1853-0318
A1Q6	1853-0318		TRANSISTOR PNP SI CHIP PD=500MW	28480	1853-0318
A1Q7	1853-0318		TRANSISTOR PNP SI CHIP PD=500MW	28480	1853-0318
A1Q8	1853-0318		TRANSISTOR PNP SI CHIP PD=500MW	28480	1853-0318
A1Q9	1853-0318		TRANSISTOR PNP SI CHIP PD=500MW	28480	1853-0318
A1Q10 ..	1853-0015	2	TRANSISTOR PNP SI CHIP PD=200MW	28480	1853-0015
A1Q11 ..	1853-0015		TRANSISTOR PNP SI CHIP PD=200MW	28480	1853-0015
A1Q12	1853-0036	3	TRANSISTOR PNP SI CHIP PD=310MW	28480	1853-0036
A1Q13	1853-0036		TRANSISTOR PNP SI CHIP PD=310MW	28480	1853-0036
A1Q14	1853-0036		TRANSISTOR PNP SI CHIP PD=310MW	28480	1853-0036
A1Q15	1854-0215		TRANSISTOR NPN SI PD=310MW FT=300MHZ	04713	SPS 3611
A1Q16	1854-0492	1	TRANSISTOR NPN SI PD=350MW FT=250MHZ	28480	1854-0492
A1Q17	1854-0487	1	ISTR:SI NPN	28480	1854-0487
A1R1	0340-0765	3	INSULATOR-XSTR	28480	0340-0765
A1R2	0683-2025	3	RESISTOR 2K 5% .25W CC TUBULAR	01121	CB2025
A1R3	0683-6215	1	RESISTOR 620 OHM 5% .25W CC TUBULAR	01121	CB6215
A1R4	0683-3915	1	RESISTOR 390 OHM 5% .25W CC TUBULAR	01121	CB3915
A1R5	0683-1035	4	RESISTOR 10K 5% .25W CC TUBULAR	01121	CB1035
A1R5	1810-0055	2	CIRCUIT; PSIV; NON-RPRABLE IN	28480	1810-0055

\*\*NOT INCLUDED IN OPTION 001

See introduction to this section for ordering information

Models 5300B and 5310A  
Manual Changes and Options

Table 7-2. 5300B Replaceable Parts  
(A1 Series 1420A and 1428A) (Cont'd)

Reference Designation	HP Part Number	Qty	Description	Mfr Code	Mfr Part Number
A1R6	0683-1035		RESISTOR 10K 5% .25W CC TUBULAR	01121	C81035
A1R7	0683-1035		RESISTOR 10K 5% .25W CC TUBULAR	01121	C81035
A1R8	0683-1055		RESISTOR 1M 5% .25W CC TUBULAR	01121	C81055
A1R9 **	0683-1525	1	RESISTOR 1.5K 5% .25W CC TUBULAR	01121	C81525
A1R10 **	0698-4037	1	RESISTOR 46.4 OHM 1% .125W F TUBULAR	16299	C4-1/8-T0-46R4-F
A1R11 **	0683-1025		RESISTOR 1K 5% .25W CC TUBULAR	01121	C81025
A1R12 **	0683-1525	4	RESISTOR 1.5K 5% .25W CC TUBULAR	01121	C81525
A1R13	0683-1525		RESISTOR 1.5K 5% .25W CC TUBULAR	01121	C81525
A1R14	0683-1035		RESISTOR 10K 5% .25W CC TUBULAR	01121	C81035
A1R15	1810-0055		CIRCUIT; PSIV; NON-RPRABLE IN	28480	1810-0055
A1R16	0683-7515	2	RESISTOR 750 OHM 5% .25W CC TUBULAR	01121	C87515
A1R17	0683-2015	8	RESISTOR 200 OHM 5% .25W CC TUBULAR	01121	C82015
A1R18	0683-2015		RESISTOR 200 OHM 5% .25W CC TUBULAR	01121	C82015
A1R19	0683-2015		RESISTOR 200 OHM 5% .25W CC TUBULAR	01121	C82015
A1R20	0683-2015		RESISTOR 200 OHM 5% .25W CC TUBULAR	01121	C82015
A1R21	0683-7515		RESISTOR 750 OHM 5% .25W CC TUBULAR	01121	C87515
A1R22			NOT ASSIGNED		
A1R23 **	0683-1525		RESISTOR 1.5K 5% .25W CC TUBULAR	01121	C81525
A1R24 **	0683-1525		RESISTOR 1.5K 5% .25W CC TUBULAR	01121	C81525
A1R25 **	2100-2061	1	RESISTOR, VAR 200OHM	28480	2100-2061
A1R26 **	0683-2715	2	RESISTOR 270 OHM 5% .25W CC TUBULAR	01121	C82715
A1R27	0683-5115	1	RESISTOR 510 OHM 5% .25W CC TUBULAR	01121	C85115
A1R28	0683-1025		RESISTOR 1K 5% .25W CC TUBULAR	01121	C81025
A1R29	0683-2035	2	RESISTOR 20K 5% .25W CC TUBULAR	01121	C82035
A1R30	0683-2015		RESISTOR 200 OHM 5% .25W CC TUBULAR	01121	C82015
A1R31	0683-2015		RESISTOR 200 OHM 5% .25W CC TUBULAR	01121	C82015
A1R32	0683-2015		RESISTOR 200 OHM 5% .25W CC TUBULAR	01121	C82015
A1R33	0683-2015		RESISTOR 200 OHM 5% .25W CC TUBULAR	01121	C82015
A1R34	0683-1025		RESISTOR 1K 5% .25W CC TUBULAR	01121	C81025
A1R35	0683-2035		RESISTOR 20K 5% .25W CC TUBULAR	01121	C82035
A1R36 *	0684-0271	1	RESISTOR 2.7 OHM 10% .25W CC TUBULAR	01121	C827G1
A1R37	0683-2025		RESISTOR 2K 5% .25W CC TUBULAR	01121	C82025
A1R38	0683-1025		RESISTOR 1K 5% .25W CC TUBULAR	01121	C81025
A1R39	0683-2715		RESISTOR 270 OHM 5% .25W CC TUBULAR	01121	C82715
A1R40	0683-1505	1	RESISTOR 15 OHM 5% .25W CC TUBULAR	01121	C81505
A1R41	0683-3305	7	RESISTOR 33 OHM 5% .25W CC TUBULAR	01121	C83305
A1R42	0683-3305		RESISTOR 33 OHM 5% .25W CC TUBULAR	01121	C83305
A1R43	0683-3305		RESISTOR 33 OHM 5% .25W CC TUBULAR	01121	C83305
A1R44	0683-3305		RESISTOR 33 OHM 5% .25W CC TUBULAR	01121	C83305
A1R45	0683-3305		RESISTOR 33 OHM 5% .25W CC TUBULAR	01121	C83305
A1R46	0683-3305		RESISTOR 33 OHM 5% .25W CC TUBULAR	01121	C83305
A1R47	0683-3305		RESISTOR 33 OHM 5% .25W CC TUBULAR	01121	C83305
A1R48	0683-1005	1	RESISTOR 10 OHM 5% .25W CC TUBULAR	01121	C81005
A1R49	0683-2025		RESISTOR 2K 5% .25W CC TUBULAR	01121	C82025
A1R50	2100-3416	1	RESISTOR, VAR 250K OHM (INCLUDES S1A, B, C)	28480	2100-3416
A1S1			PART OF A1R50: NSR		
A1S2	3101-0684	1	SWITCH; SL; DPDT NS; 1A 125VAC	28480	3101-0684
A1T1	9100-3012	1	TRANSFORMER:DRIVER	28480	9100-3012
A1T2	9100-3011	1	TRANSFORMER	28480	9100-3011
A1U1	RS 1820-0634	1	IC DGTL COUNTER	28480	1820-0634
A1U2	RS 1820-0633	1	IC:M.O.S. TIME BASE	28480	1820-0633
A1U3	RS 1820-1166	1	IC DGTL DM85L 51N FLIP-FLOP	27014	DM85L51N
A1U4 **	1820-0806	1	IC DGTL MC10109L GATE	04713	MC10109P
A1U5	RS 1816-0412	1	ROM, 256-BIT	28480	1816-0412
A1U6	RS 1820-1251	1	IC, DIGITAL TTL LS DECADE COUNTER/LATCH	01295	74LS196N
A1U7	RS 1820-0214	1	IC DGTL SN74 42 N DECODER	01295	SN7442N
A1U8	RS 1820-0099	1	IC DGTL SN74 93 N COUNTER	01295	SN7493N
A1U9	RS 1820-0632	1	IC:LSI CONTROL	28480	1820-0632
A1U10	RS 1820-0377	1	IC DGTL SN74H 50 N GATE	01295	SN74H50N
A1U11	1820-0370	1	IC DGTL SN74H 00 N GATE	01295	SN74H00N
A1U12	1820-0586	1	IC DGTL DM74L 04N INVERTER	27014	DM74L04N
A1U13	RS 1820-0658	1	IC DGTL MULTIPLEXER	07263	93L120C
A1U14	RS 1820-1037	1	IC DGTL SN74 46AN DECODER	01295	SN7446AN
A1U15	1820-0585	1	IC DGTL DM74L 03N GATE	27014	DM74L03N
A1X2	1251-3506	1	CONNECTOR; 12-CONT; FEM; POST TYPE	28480	1251-3506
A1XU5	1200-0473	1	SOCKET; ELEC; IC 16-CONT DOUBLE STRIP PKG	02660	821-20012-164
A1XU9	1200-0525	1	SOCKET; ELEC; IC 20-CONT DBL STRP PKG	00779	583640-2
A1Y1 **	0410-0423	1	CRYSTAL:QUARTZ	28480	0410-0423
	0905-0479	1	GASKET, TEFLON; (A1J1 INSULATOR)	28480	0905-0479
A1A1	05300-60018	1	BOARD ASSY, DISPLAY	28480	05300-60018

RS = RECOMMENDED  
SPARE PART

\*FACTORY SELECTED PART (Replace with original value)

\*\*NOT INCLUDED IN OPTION 001

See introduction to this section for ordering information

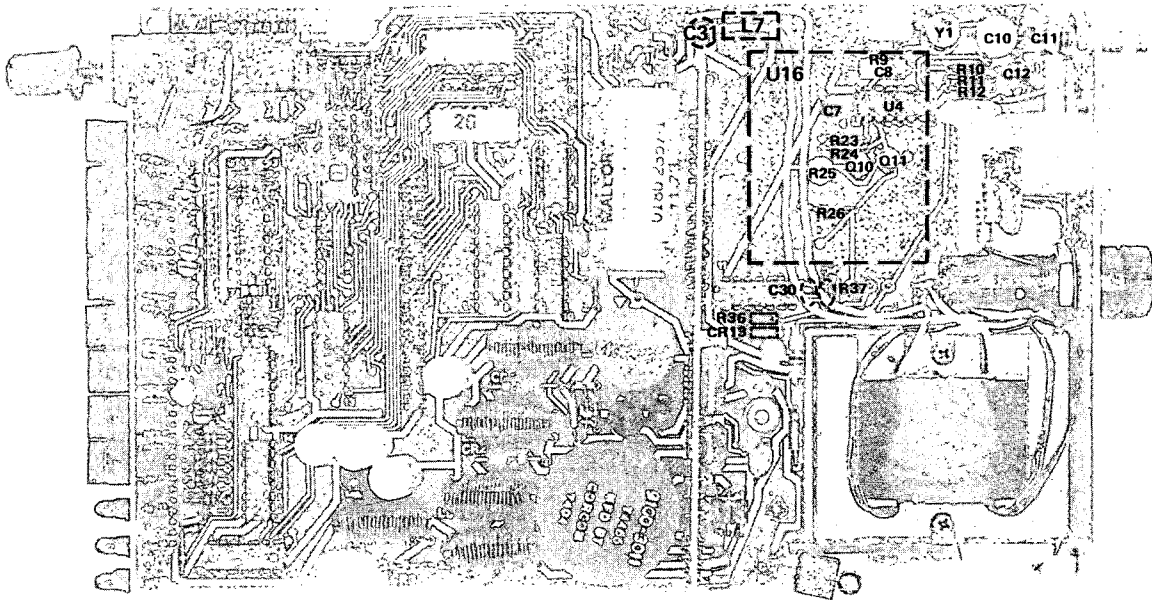

**FIELD CONVERSION FOR ADDING OPTION 001 (Series 1420A and 1428A)**

The following parts are required for field conversion of series 1420A or 1428A Part No. 05300-60017 circuit boards into Part No. 05300-60020 circuit boards with Option 001:

A1C30	0140-0192	C: fxd 68 pF 5% 300 Vdcw
A1C31	0180-0428	C: fxd 68 $\mu$ F 20% 6 Vdcw solid tantalum
A1CR13	1901-0040	Diode, Si: switching
A1R36	0683-2015	R: fxd comp 200 ohm 5% 1/4W
A1L7	9140-0210	Coil: fxd molded 100 $\mu$ H 5%
A1U16	0960-0318	Oscillator Assembly: TCXO

1. Remove components C7, C8, C10, C11, C12, R9, R10, R11, R12, R23, R24, R25, R26, R36, Q10, Q11, Y1, and U4 shown in above figure.
2. Install A1C30 (0140-0192) in holes adjacent to R37.
3. Add capacitor A1C31 (0180-0428) and A1L7 choke in holes provided near the edge of the circuit board.
4. Add diode A1CR13 and 200 ohm resistor for A1R36.
5. Add A1U16 Oscillator Assembly in area shown by dashed lines in the above illustration.
6. Change circuit board Part No. 05300-60017 to 05300-60020.
7. Check and adjust frequency of A1U16 oscillator assembly. Use the procedure given in paragraph 5-53. Set the oscillator to the frequency indicated by the marking on the case. When making frequency adjustments, be sure the ambient temperature is maintained as closely as possible to 25°C (77°F). Deviation in ambient temperature can cause the oscillator drift characteristics to exceed the specifications given in Table 1-4. Allow a warm-up time of at least one hour before making adjustments.

Figure 7-1. 5300B Parts Locations with Option 001 Time Base (Series 1420A and 1428A)

Models 5300B and 5310A  
Manual Changes and Options

Table 7-2. 5300B Replaceable Parts  
(A1 Series 1420A and 1428A) (Cont'd)

Reference Designation	HP Part Number	Qty	Description	Mfr Code	Mfr Part Number
A1R6	0683-1035		RESISTOR 10K 5% .25W CC TUBULAR	01121	CB1035
A1R7	0683-1035		RESISTOR 10K 5% .25W CC TUBULAR	01121	CB1035
A1R8	0683-1055	1	RESISTOR 1M 5% .25W CC TUBULAR	01121	CB1055
A1R9 **	0683-1525	5	RESISTOR 1.5K 5% .25W CC TUBULAR	01121	CB1525
A1R10 **	0698-4037	1	RESISTOR 46.4 OHM 1% .125W F TUBULAR	16299	C4-1/8-T0-46R4-F
A1R11 **	0683-1025	4	RESISTOR 1K 5% .25W CC TUBULAR	01121	CB1025
A1R12 **	0683-1525		RESISTOR 1.5K 5% .25W CC TUBULAR	01121	CB1525
A1R13	0683-1525		RESISTOR 1.5K 5% .25W CC TUBULAR	01121	CB1525
A1R14	0683-1035		RESISTOR 10K 5% .25W CC TUBULAR	01121	CB1035
A1R15	1810-0055		CIRCUIT; PSIV; NON-RPRABLE IN	28480	1810-0055
A1R16	0683-7515	2	RESISTOR 750 OHM 5% .25W CC TUBULAR	01121	CB7515
A1R17	0683-2015	8	RESISTOR 200 OHM 5% .25W CC TUBULAR	01121	CB2015
A1R18	0683-2015		RESISTOR 200 OHM 5% .25W CC TUBULAR	01121	CB2015
A1R19	0683-2015		RESISTOR 200 OHM 5% .25W CC TUBULAR	01121	CB2015
A1R20	0683-2015		RESISTOR 200 OHM 5% .25W CC TUBULAR	01121	CB2015
A1R21	0683-7515		RESISTOR 750 OHM 5% .25W CC TUBULAR	01121	CB7515
A1R22			NOT ASSIGNED		
A1R23 **	0683-1525		RESISTOR 1.5K 5% .25W CC TUBULAR	01121	CB1525
A1R24 **	0683-1525		RESISTOR 1.5K 5% .25W CC TUBULAR	01121	CB1525
A1R25 **	2100-2061	1	RESISTOR, VAR 200 OHM	28480	2100-2061
A1R26 **	0683-2715	2	RESISTOR 270 OHM 5% .25W CC TUBULAR	01121	CB2715
A1R27	0683-5115	1	RESISTOR 510 OHM 5% .25W CC TUBULAR	01121	CB5115
A1R28	0683-1025		RESISTOR 1K 5% .25W CC TUBULAR	01121	CB1025
A1R29	0683-2035	2	RESISTOR 20K 5% .25W CC TUBULAR	01121	CB2035
A1R30	0683-2015		RESISTOR 200 OHM 5% .25W CC TUBULAR	01121	CB2015
A1R31	0683-2015		RESISTOR 200 OHM 5% .25W CC TUBULAR	01121	CB2015
A1R32	0683-2015		RESISTOR 200 OHM 5% .25W CC TUBULAR	01121	CB2015
A1R33	0683-2015		RESISTOR 200 OHM 5% .25W CC TUBULAR	01121	CB2015
A1R34	0683-1025		RESISTOR 1K 5% .25W CC TUBULAR	01121	CB1025
A1R35	0683-2035		RESISTOR 20K 5% .25W CC TUBULAR	01121	CB2035
A1R36 *	0684-0271	1	RESISTOR 2.7 OHM 10% .25W CC TUBULAR	01121	CB27G1
A1R37	0683-2025		RESISTOR 2K 5% .25W CC TUBULAR	01121	CB2025
A1R38	0683-1025		RESISTOR 1K 5% .25W CC TUBULAR	01121	CB1025
A1R39	0683-2715		RESISTOR 270 OHM 5% .25W CC TUBULAR	01121	CB2715
A1R40	0683-1505	1	RESISTOR 15 OHM 5% .25W CC TUBULAR	01121	CB1505
A1R41	0683-3305	7	RESISTOR 33 OHM 5% .25W CC TUBULAR	01121	CB3305
A1R42	0683-3305		RESISTOR 33 OHM 5% .25W CC TUBULAR	01121	CB3305
A1R43	0683-3305		RESISTOR 33 OHM 5% .25W CC TUBULAR	01121	CB3305
A1R44	0683-3305		RESISTOR 33 OHM 5% .25W CC TUBULAR	01121	CB3305
A1R45	0683-3305		RESISTOR 33 OHM 5% .25W CC TUBULAR	01121	CB3305
A1R46	0683-3305		RESISTOR 33 OHM 5% .25W CC TUBULAR	01121	CB3305
A1R47	0683-3305		RESISTOR 33 OHM 5% .25W CC TUBULAR	01121	CB3305
A1R48	0683-1005	1	RESISTOR 10 OHM 5% .25W CC TUBULAR	01121	CB1005
A1R49	0683-2025		RESISTOR 2K 5% .25W CC TUBULAR	01121	CB2025
A1R50	2100-3416	1	RESISTOR, VAR 250K OHM (INCLUDES S1A, B, C)	28480	2100-3416
A1S1			PART OF A1R50: NSR		
A1S2	3101-0684	1	SWITCH; SL; DPDT NS; 1A 125VAC	28480	3101-0684
A1T1	9100-3012	1	TRANSFORMER:DRIVER	28480	9100-3012
A1T2	9100-3011	1	TRANSFORMER	28480	9100-3011
A1U1	RS 1820-0634	1	IC DGTL COUNTER	28480	1820-0634
A1U2	RS 1820-0633	1	IC:M.O.S. TIME BASE	28480	1820-0633
A1U3	RS 1820-1166	1	IC DGTL DM85L 51N FLIP-FLOP	27014	DM85L51N
A1U4 **	1820-0806	1	IC DGTL MC10109L GATE	04713	MC10109P
A1U5	RS 1816-0412	1	ROM, 256-BIT	28480	1816-0412
A1U6	RS 1820-1251	1	IC, DIGITAL TTL LS DECADE COUNTER/LATCH	01295	74LS196N
A1U7	RS 1820-0214	1	IC DGTL SN74 42 N DECODER	01295	SN7442N
A1U8	RS 1820-0099	1	IC DGTL SN74 93 N COUNTER	01295	SN7493N
A1U9	RS 1820-0632	1	IC:LSI CONTROL	28480	1820-0632
A1U10	1820-0377	1	IC DGTL SN74H 50 N GATE	01295	SN74H50N
A1U11	1820-0370	1	IC DGTL SN74H 00 N GATE	01295	SN74H00N
A1U12	1820-0586	1	IC DGTL DM74L 04N INVERTER	27014	DM74L04N
A1U13	1820-0658	1	IC DGTL MULTIPLEXER	07263	93L12DC
A1U14	RS 1820-1037	1	IC DGTL SN74 46AN DECODER	01295	SN7446AN
A1U15	1820-0585	1	IC DGTL DM74L 03N GATE	27014	DM74L03N
A1XA2	1251-3506	1	CONNECTOR; 12-CONT; FEM; POST TYPE	28480	1251-3506
A1XU5	1200-0473	1	SOCKET; ELECT; IC 16-CONT DOUBLE STRIP PKG	02680	821-20012-164
A1XU9	1200-0525	1	SOCKET; ELECT; IC 20-CONT DBL STRP PKG	00779	583640-2
A1Y1 **	0410-0423	1	CRYSTAL:QUARTZ	28480	0410-0423
	0905-0479	1	GASKET, TEFLON; (A1J1 INSULATOR)	28480	0905-0479
A1A1	05300-60018	1	BOARD ASSY, DISPLAY	28480	05300-60018

RS = RECOMMENDED  
SPARE PART

\*FACTORY SELECTED PART (Replace with original value)  
\*\*NOT INCLUDED IN OPTION 001

See introduction to this section for ordering information



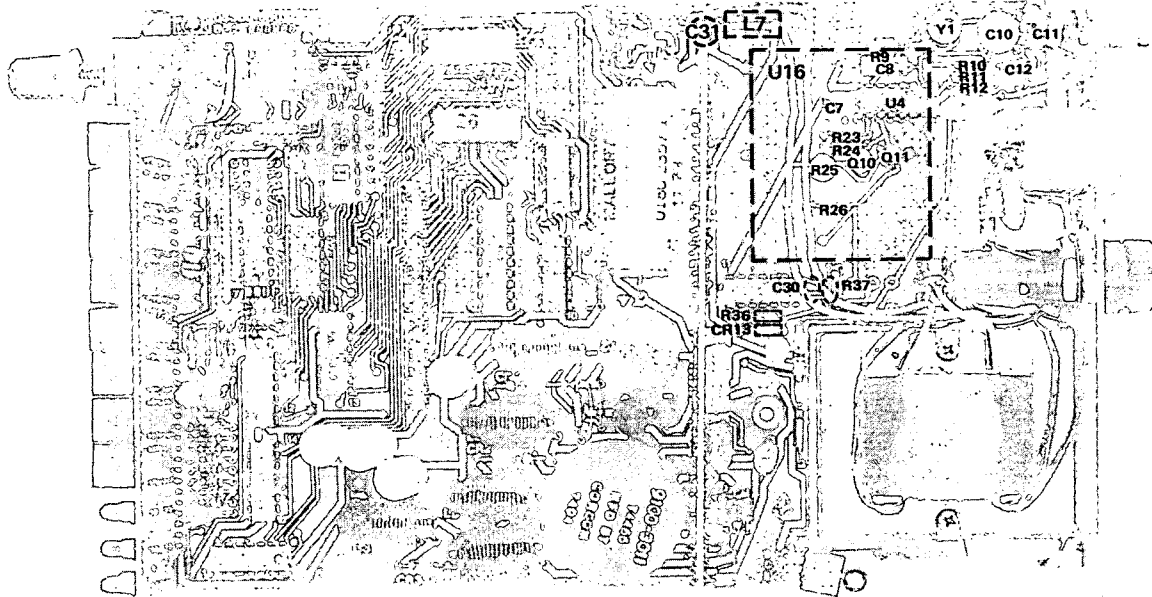

#### FIELD CONVERSION FOR ADDING OPTION 001 (Series 1420A and 1428A)

The following parts are required for field conversion of series 1420A or 1428A Part No. 05300-60017 circuit boards into Part No. 05300-60020 circuit boards with Option 001:

A1C30	0140-0192	C: fxd 68 pF 5% 300 Vdcw
A1C31	0180-0428	C: fxd 68 $\mu$ F 20% 6 Vdcw solid tantalum
A1CR13	1901-0040	Diode, Si: switching
A1R36	0683-2015	R: fxd comp 200 ohm 5% 1/4W
A1L7	9140-0210	Coil: fxd molded 100 $\mu$ H 5%
A1U16	0960-0318	Oscillator Assembly: TCXO

1. Remove components C7, C8, C10, C11, C12, R9, R10, R11, R12, R23, R24, R25, R26, R36, Q10, Q11, Y1, and U4 shown in above figure.
2. Install A1C30 (0140-0192) in holes adjacent to R37.
3. Add capacitor A1C31 (0180-0428) and A1L7 choke in holes provided near the edge of the circuit board.
4. Add diode A1CR13 and 200 ohm resistor for A1R36.
5. Add A1U16 Oscillator Assembly in area shown by dashed lines in the above illustration.
6. Change circuit board Part No. 05300-60017 to 05300-60020.
7. Check and adjust frequency of A1U16 oscillator assembly. Use the procedure given in paragraph 5-53. Set the oscillator to the frequency indicated by the marking on the case. When making frequency adjustments, be sure the ambient temperature is maintained as closely as possible to 25°C (77°F). Deviation in ambient temperature can cause the oscillator drift characteristics to exceed the specifications given in Table 1-4. Allow a warm-up time of at least one hour before making adjustments.

Figure 7-1. 5300B Parts Locations with Option 001 Time Base (Series 1420A and 1428A)

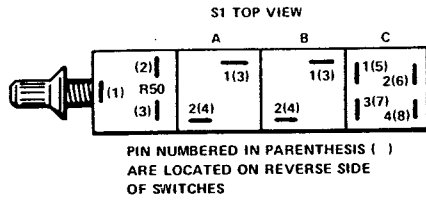

A1

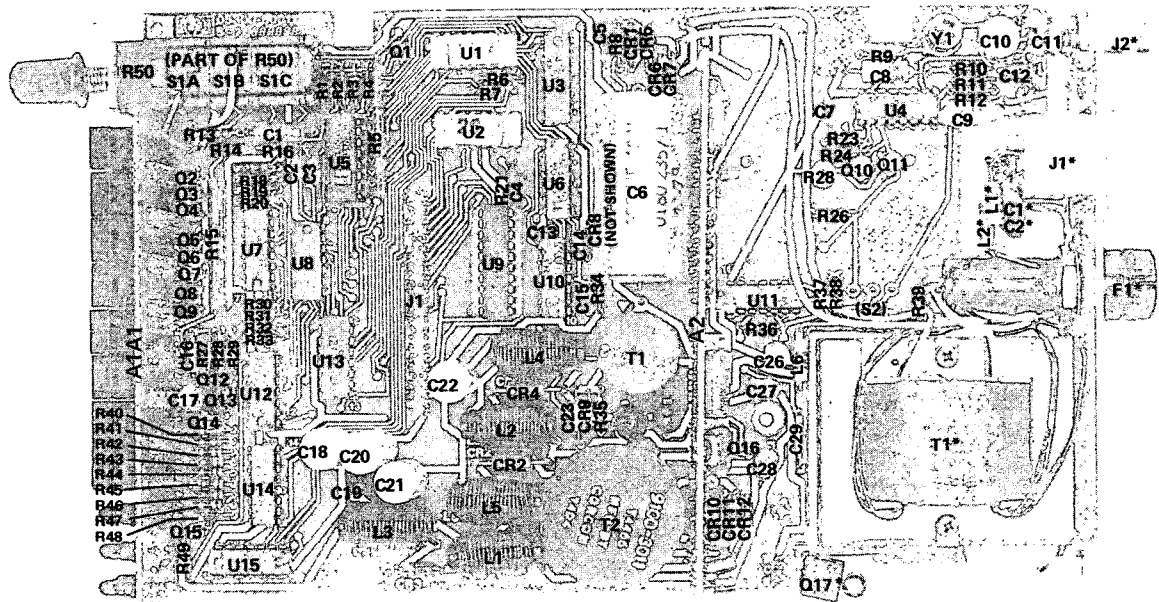
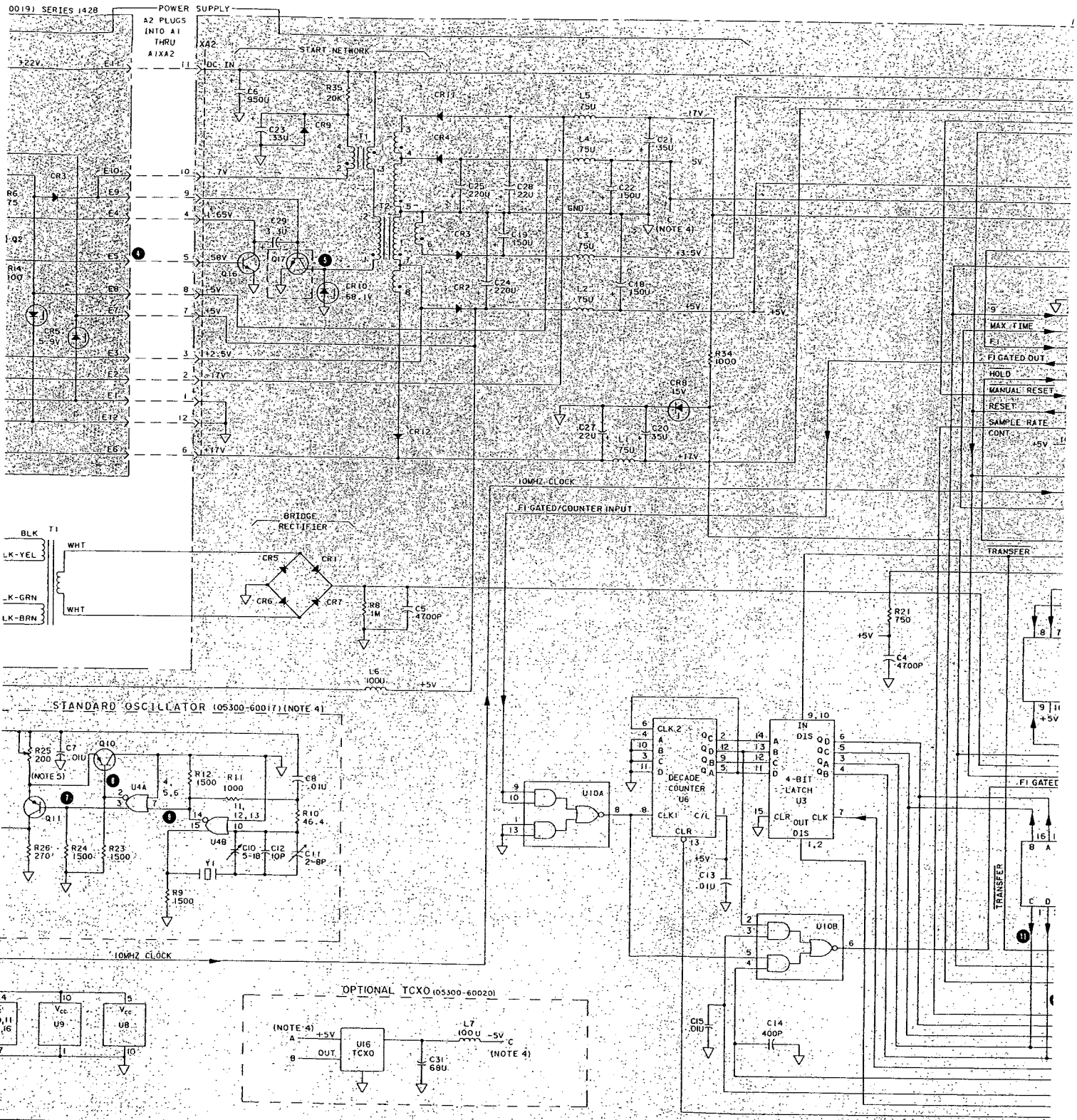

Figure 7-2. 5300B Parts Locations on A1 with Standard  
Time Base (Series 1420A or 1428A)







A1A1 DISPLAY ASSEMBLY (05300-60018) SERIES

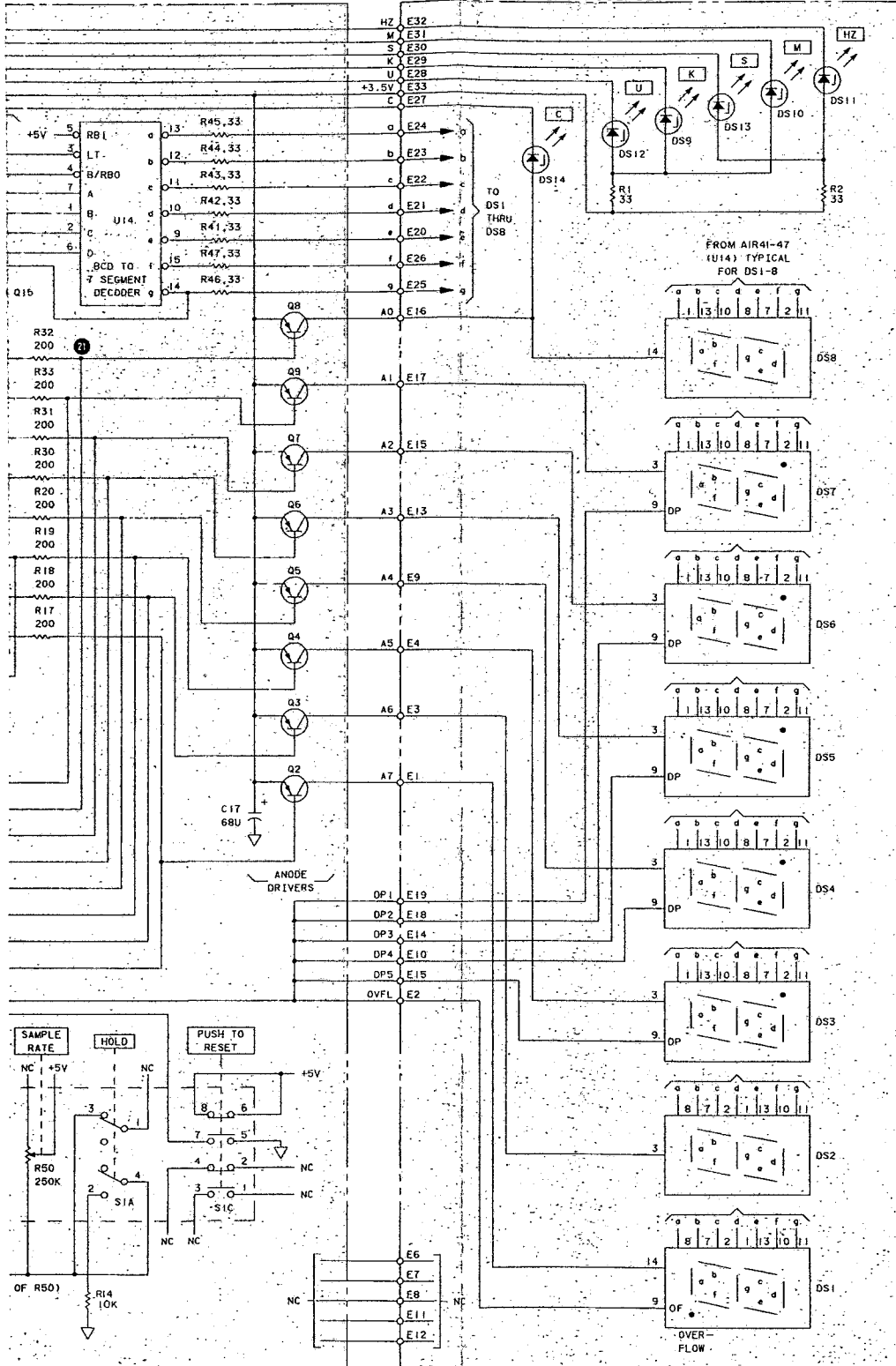

NOTES

1. REFERENCE DESIGNATIONS WITHIN THIS ASSEMBLY ARE ABBREVIATED. ADD ASSEMBLY NUMBER TO ABBREVIATION FOR COMPLETE DESCRIPTION.
2. UNLESS OTHERWISE INDICATED: RESISTANCE VALUES ARE IN OHMS. CAPACITANCE VALUES ARE IN FARADS. INDUCTANCE VALUES ARE IN HENRIES.
3. ASTERISK (\*) INDICATES SELECTED COMPONENT. AVERAGE VALUES SHOWN. STANDARD ASSY (05300-60017) DOES NOT INCLUDE AICR13 AND AIC30; VALUE OF AIR36 IS APPROXIMATELY 2.7 OHMS. OPTION 001 ASSY (05300-60020) INCLUDES AICR13 AND AIC30; VALUE OF AIR36 IS APPROXIMATELY 200 OHMS.
4. ON 05300-60020 ASSEMBLY (OPT 001) TCXO REPLACES THE STANDARD OSCILLATOR CIRCUIT. A, B AND C INDICATE THE REPLACEMENT CONNECTION POINTS.
5. FOR INSTRUMENTS WITH STANDARD OSCILLATOR, AIR25 IS ADJUSTED FOR A SQUARE WAVE CONNECT OSCILLOSCOPE TO J2 OSC FOR ADJUSTMENT.

ACTIVE ELEMENTS TABLE

A1		A1A1		A2	
REFERENCE DESIGNATIONS	HP PART NUMBER	REFERENCE DESIGNATIONS	HP PART NUMBER	REFERENCE DESIGNATIONS	HP PART NUMBER
CR1, 3.5, 6.7	1901 0028	DS1 8*	1990 0469(CI)	CR1, 2	1901 0040
CR2	1901 1081		or	CR3	1901 0050
CR3	1902 3205		1990 0470(XD)	CR4	1902 0689
CR9	1901 0050		or	CR5, 6	1902 3110
CR10	1902 3381	DS9 14	1990 0471(E)	CR7, 8	1902 0556
Q1, 5	1854 0215	CR1, 2	1901 0040	Q2	1854 0023
Q2, 3, 4, 5	1853 0318	CR3	1901 0050	Q3	1855 0387
Q6, 7, 8, 9	1853 0015	CR4	1902 0689	Q4, 5	1853 0086
Q10, 11	1853 0036	CR5, 6	1902 3110		
Q12, 13, 14	1853 0036	CR7, 8	1902 0556		
Q16	1854 0492	Q1	1853 0020		
Q17	1854 0487	Q2	1854 0023		
U1	1820 0634	Q3	1855 0387		
U2	1820 0633	Q4	1853 0086		
U3	1820 1166	Q5	1853 0086		
U4	1820 0806				
U5	1816 0412				
U6	1820 1251				
U7	1820 0244				
U8	1820 0090				
U9	1820 0637				
U10	1820 0377				
U11	1820 0370				
U12	1820 0586				
U13	1820 0658				
U14	1820 1037				
U15	1820 0585				

\*These parts are matched for brightness by suffix letter C or D or E

Figure 7-3. 5300B Schematic Diagrams A1 Series 1420A and 1428A

Figure 7-3  
**5300B SCHEMATIC DIAGRAMS  
A1 SERIES 1420A AND 1428A**

## SECTION VIII

### SCHEMATIC DIAGRAMS

#### 8-1. INTRODUCTION

8-2. This section contains schematic diagrams, part locators, and waveforms. The part locators show the location by reference designator. On each schematic a table of active elements is included which lists reference designations and HP part numbers for each integrated circuit, diode, and transistor.

#### 8-3. SCHEMATIC DIAGRAM NOTES, ASSEMBLY NUMBERS, AND REFERENCE DESIGNATORS

8-4. Figure 8-1 shows the symbols used on the schematic diagrams. At the bottom of Figure 8-1, the system for reference designators, assemblies, and sub-assemblies are shown.

#### 8-5. Reference Designations

8-6. Assemblies such as printed circuit boards are assigned numbers in sequence, A1, A2, etc. As shown in Figure 8-1, subassemblies within an assembly are given a subordinate A number. For example, rectifier subassembly A1 has the complete designator of A25A1. For individual components, the complete designator is determined by adding the assembly number and subassembly number if any. For example, CR1 on the rectifier assembly is designated A25A1CR1. On each schematic, a table of reference designators lists the total designators assigned in each category with any "not used" noted.

#### 8-7. Identification Markings on Printed-Circuit Boards

8-8. HP printed-circuit boards (see Figure 8-1) have four identification numbers: an assembly part number, a series number, a revision letter, and a production code.

8-9. The assembly part number has 10 digits (such as 05300-60001) and is the primary identification. All assemblies with the same part number are interchangeable. When a production change is made on an assembly that makes it incompatible with previous assemblies, a change in part number is required. The series number (such as 1248A) is used to document minor electrical changes. As changes are made, the series number is incremented. When replacement boards are ordered, you may receive a replacement with a different series number. If there is a difference between the series number marked on the board and the schematic in this manual, a minor electrical difference exists. If the number on the printed-circuit board is lower than that on the schematic, refer to Section VII for back dating information. If it is higher, refer to the loose leaf manual change sheets for this manual. If the manual change sheets are missing, contact your local Hewlett-Packard Sales and Service Office. See the listing on the back cover of this manual.

8-10. Revision letters (A, B, etc.) denote changes in printed-circuit layout. For example, if a capacitor type is changed (electrical value may remain the same) and requires different spacing for its leads, the printed-circuit board layout is changed and the revision letter is incremented to the next letter. When a revision letter changes, the series number is also usually changed. The production code is the four-digit, seven-segment number used for production purposes.



**SYMBOLS**

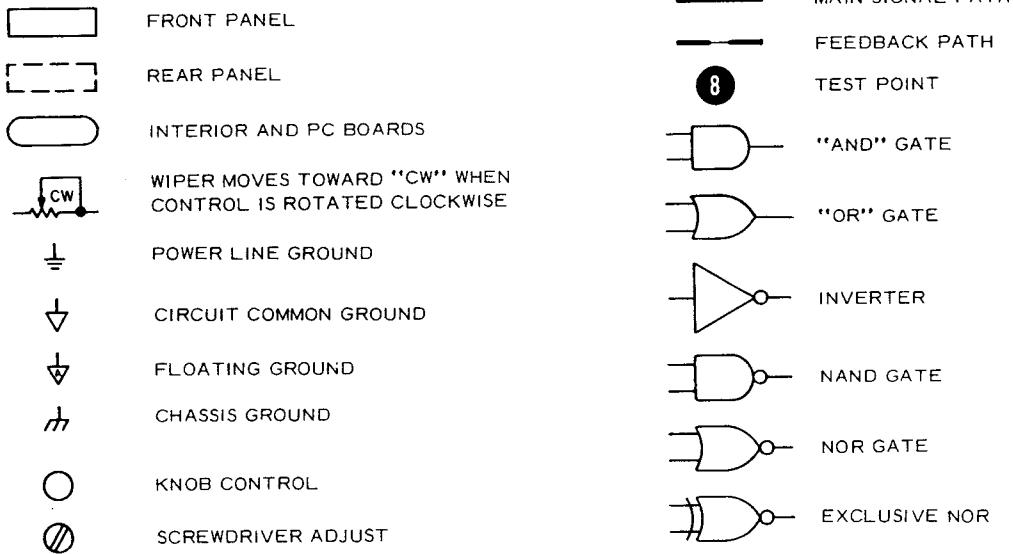

**PRINTED CIRCUIT BOARD IDENTIFICATION**

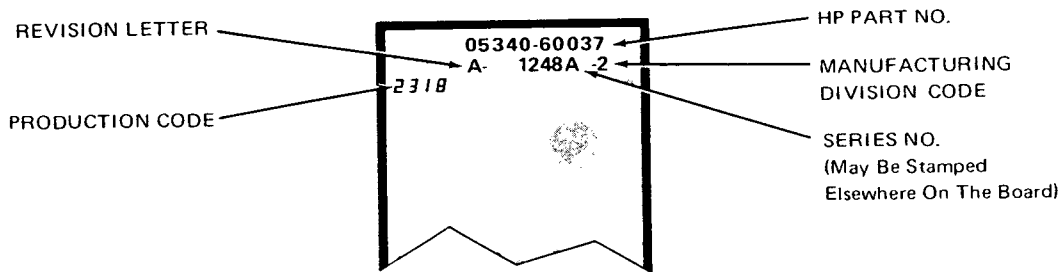

**REFERENCE DESIGNATIONS**

REFERENCE DESIGNATIONS WITHIN ASSEMBLIES ARE ABBREVIATED. ADD ASSEMBLY NUMBER TO ABBREVIATION FOR COMPLETE DESCRIPTION. JACKS ARE THE STATIONARY CONNECTORS AND PLUGS ARE THE MORE MOVEABLE OF TWO CONNECTORS.

ASSEMBLY	ABBREVIATION	COMPLETE DESCRIPTION
A25	C1	A25C1
A25A1	CR1	A25A1CR1
NO PREFIX	J3	J3

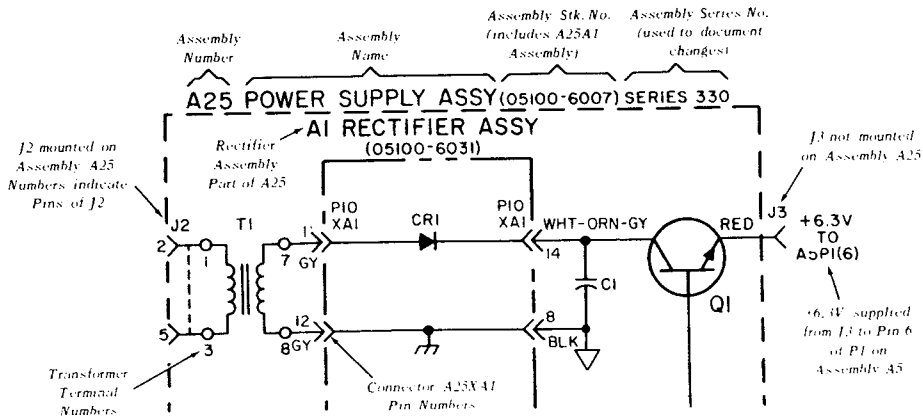
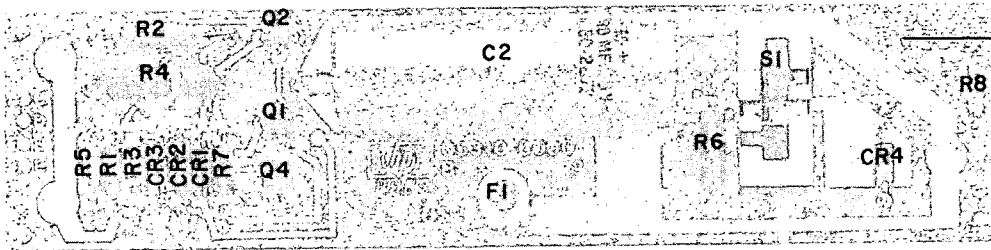

Figure 8-1. Schematic Diagram Notes



Q3 LOCATED  
ON FRONT  
PANEL

NOTES

1. REFERENCE DESIGNATIONS WITHIN THIS ASSEMBLY ARE ABBREVIATED. ADD ASSEMBLY NUMBER TO ABBREVIATION FOR COMPLETE DESCRIPTION.
2. UNLESS OTHERWISE INDICATED:  
RESISTANCE IN OHMS;  
CAPACITANCE IN PICOFARADS;

REFERENCE DESIGNATIONS

NO PREFIX	A1	A2
BTI		C2 CR1-4
DSI	J1 P1	F1  Q1-2,4 R1-8 S1

A2C1 DELETED  
A2Q3 DELETED

TABLE OF ACTIVE COMPONENTS

REFERENCE DESIGNATIONS	HP PART NUMBER
NO PREFIX	
DSI	1990-0325
Q3	1854-0420
A2	
CR1,4	1901-0028
CR2	1902-0693
CR3	1901-0044
Q1,2,4	1853-0086

05310-D-1

Figure 8-2. 5310A Battery Pack Parts Locations

**A1 INTERCONNECT BOARD ASSEMBLY**  
(05310-60002)

**A2 POWER SUPPLY BOARD ASSEMBLY**  
(05310-60001)

(TOP CONNECTOR)

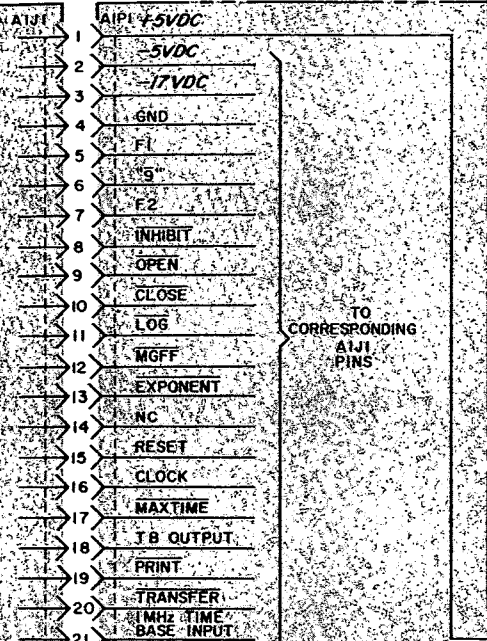

5300A  
MEASURING  
SYSTEM

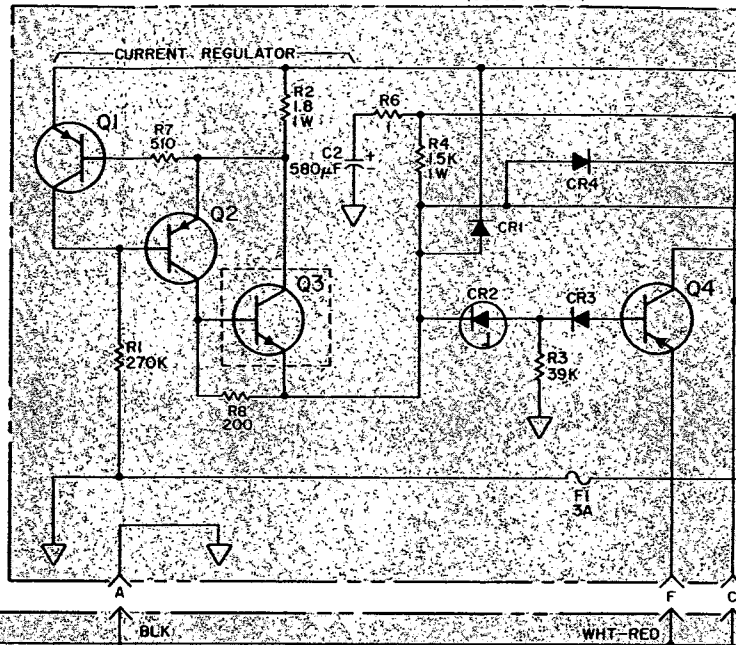

22	TIME BASE SELECT A
23	TIME BASE SELECT B
24	TIME BASE SELECT C
25	+22VDC
26	+17VDC
27	Hz
28	M
29	S
30	K
31	µ
32	MANUAL RESET
33	DP1
34	DP2
35	R/L
36	DIGIT ADDRESS "X"
37	DIGIT SELECT "X"
38	DIGIT ADDRESS "Y"
39	DIGIT SELECT "Y"
40	DIGIT ADDRESS "Z"
41	DIGIT SELECT "Z"
42	DATA "D"
43	DATA "C"
44	DATA "B"
45	DATA "A"
46	DP3
47	DP4
48	DP5
49	GND
50	DC-IN

(TOP CONNECTOR)

BLY

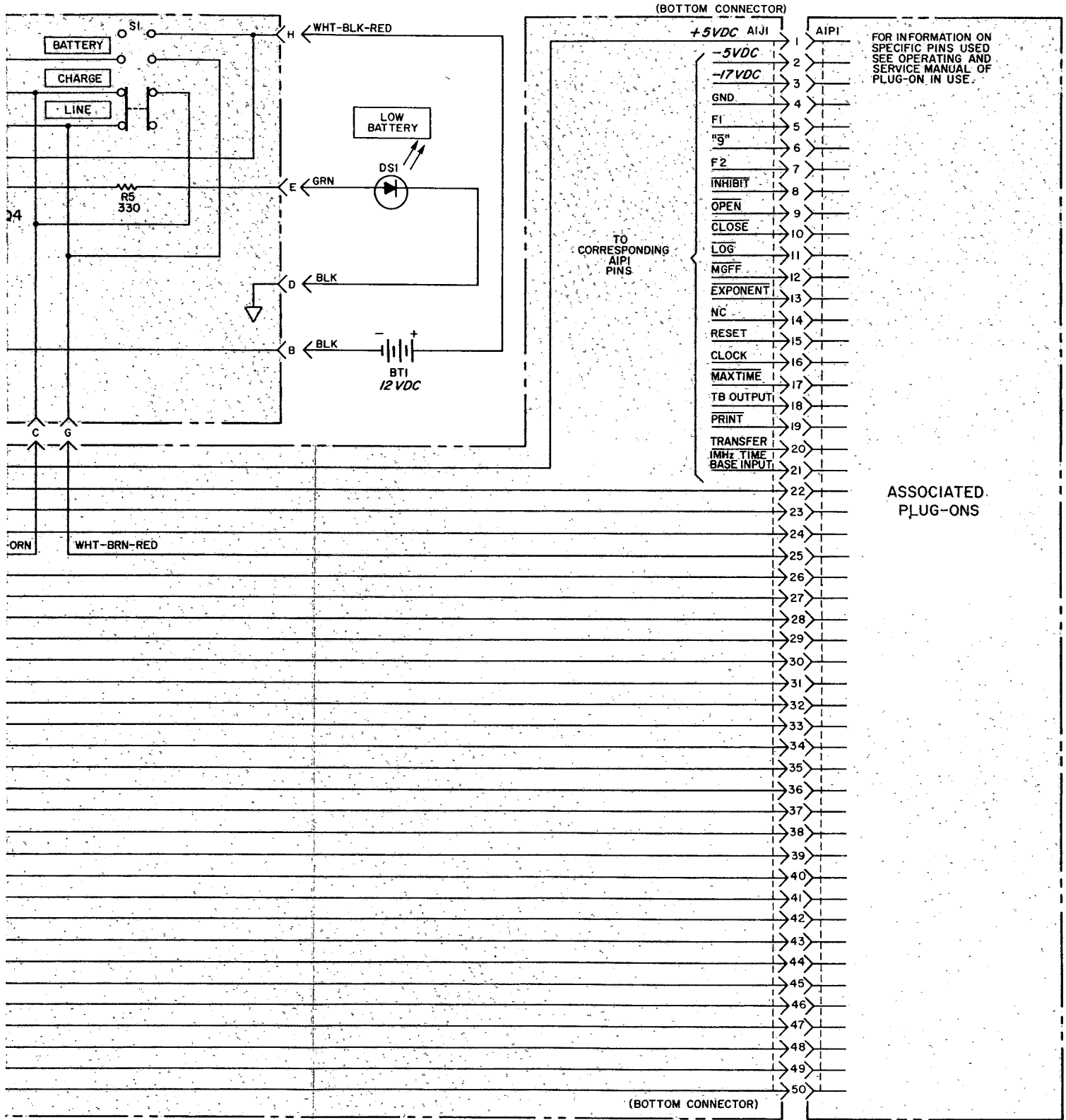
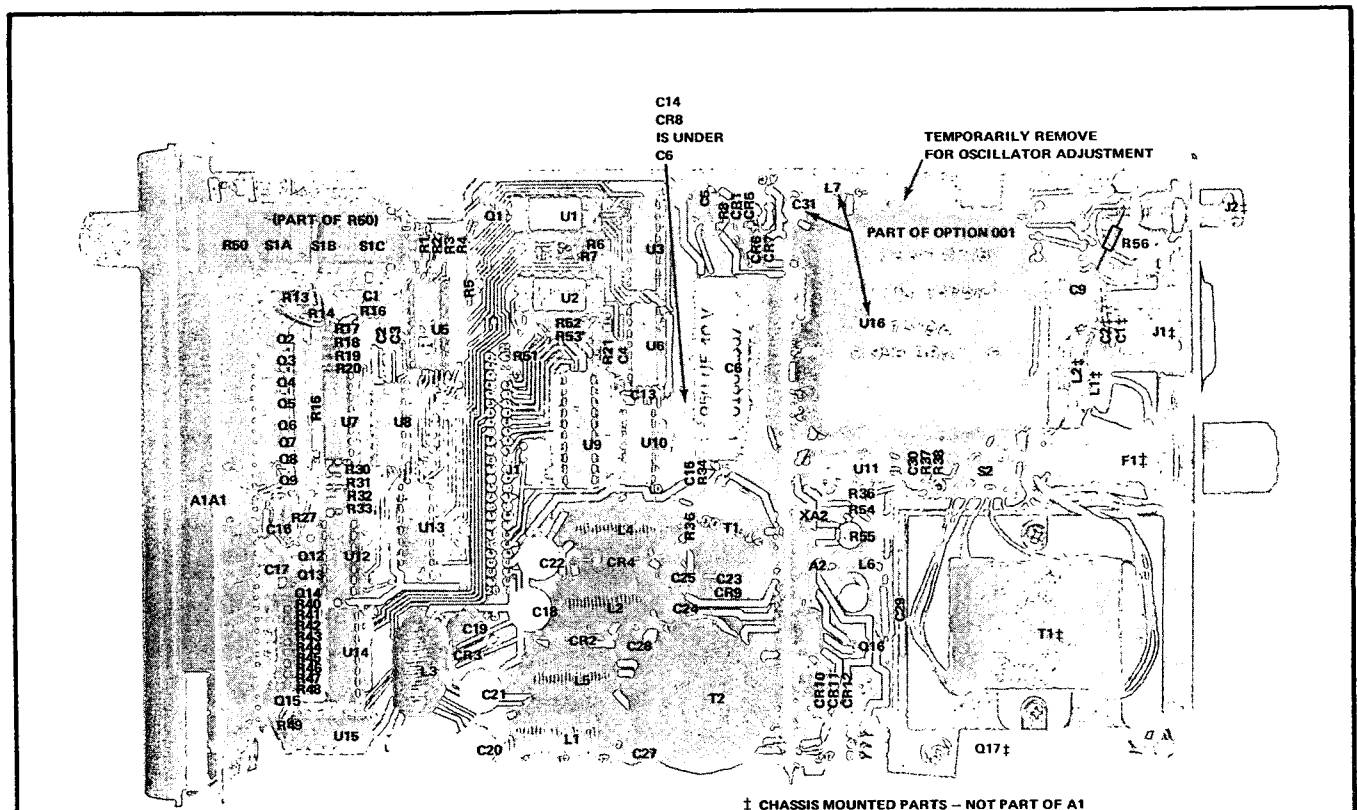

Figure 8-3. 5310A Battery Pack Schematic Diagram

Figure 8-3  
**5310A BATTERY PACK SCHEMATIC DIAGRAM**

(See Page 8-3)



### FIELD CONVERSION FOR ADDING OPTION 001 (Series 1452A, 1636A, or 1704A)

The following parts are required for field conversion of the above series of 05300-60017 circuit boards into Part No. 05300-60020 circuit boards with Option 001 temperature controlled crystal oscillator (TCXO).

Capacitor A1C31 (0140-0428), choke A1L7 (9140-0210), resistor A1R56 (0683-1015) and A1U16 TCXO Part No. 0960-0318. See Table 6-1 for a description of these parts on circuit board 05300-60020 for Option 001.

1. Remove capacitors A1C7, A1C8, A1C10, A1C11, A1C12; resistors A1R9, A1R10, A1R11, A1R12, A1R22, A1R23, A1R24, A1R26; transistors A1Q10, A1Q11; crystal A1Y1; and integrated circuit A1U4. See Figure 8-6 for the location of these parts.
2. Add capacitor A1C31 (68  $\mu$ F) and choke A1L7 (100  $\mu$ H) in holes provided near edge of circuit board. Mount A1U16 in the location shown above. Replace wire between J2 and A1C9 with A1R56 (100 ohm) resistor. See schematic diagram Figure 8-8.
3. Change part number on circuit board from 05300-60017 to 05300-60020 for Option 001.
4. Check and adjust frequency of A1U16 oscillator after a warm up time of at least 1 hour. Use the procedure given in paragraph 5-53. Set the TCXO oscillator to the frequency indicated by the marking on the case. When making adjustments or checking oscillator frequency, be sure the ambient temperature is maintained as closely as possible to 25°C (77°F). Deviation in ambient temperature can cause the oscillator drift characteristics to exceed the specifications given in Table 1-4. See symmetry adjustment note on schematic diagram.

Figure 8-4. 5300B Parts Locations with Option 001 Time Base

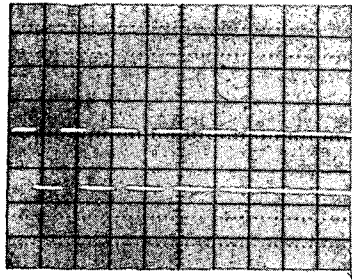

1 1V/div  
50 $\mu$ sec/div

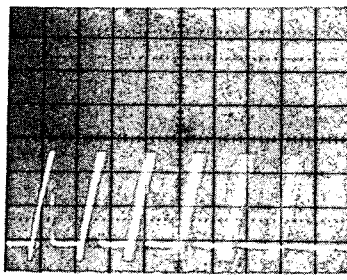

2 .5V/div  
50 $\mu$ sec/div

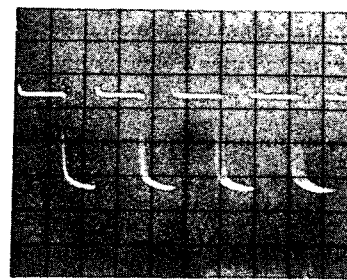

3 .5V/div  
50 $\mu$ sec/div

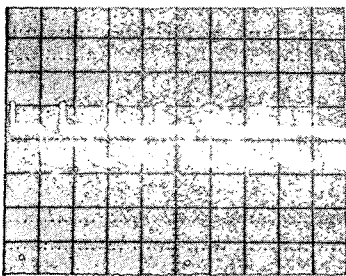

4 .02V/div  
50 $\mu$ sec/div

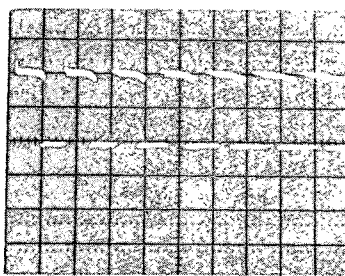

5 2V/div  
50 $\mu$ sec/div

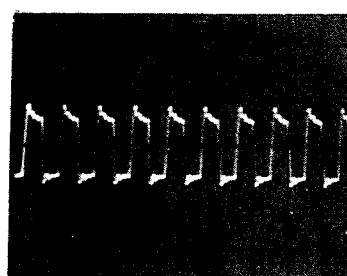

6 .2V/div  
.1 $\mu$ sec/div

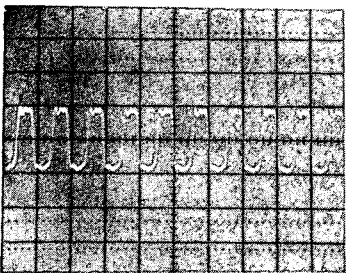

7 .05V/div  
.1 $\mu$ sec/div

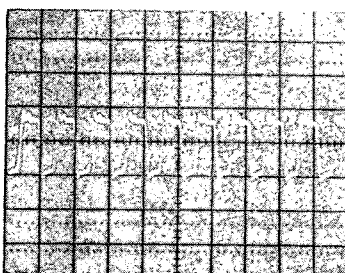

8 .05V/div  
.1 $\mu$ sec/div

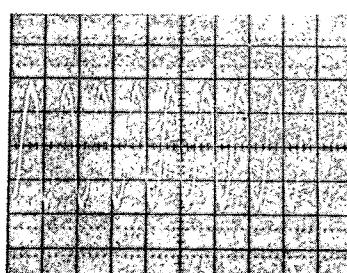

9 .02V/div  
.1 $\mu$ sec/div

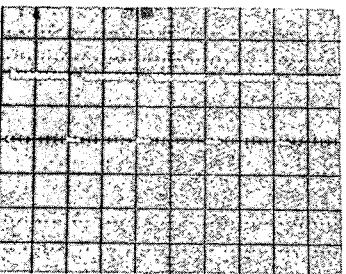

10 .2V/div  
.5 $\mu$ sec/div

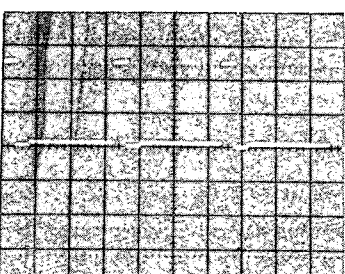

11 .2V/div  
1msec/div

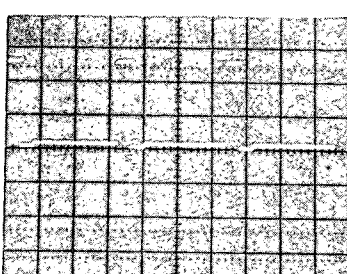

12 .2V/div  
1msec/div

All waveforms coupled through 10:1 divider probe; + (positive) slope internal triggering. 5300B separated from any plug-on; Diagnostic Test Card B, Test 7 plugged into 5300B (or "Alternate Method" Test 7 wired to plug in 5300B).

Figure 8-5. 5300B Waveforms Photographs

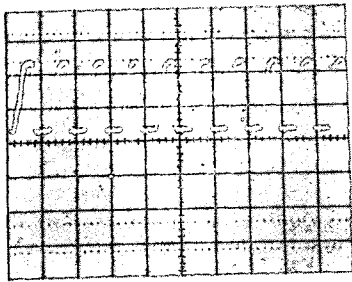

13 .2V/div  
1msec/div

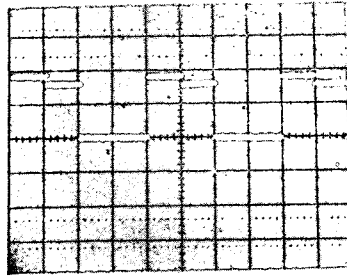

14 .2V/div  
.2msec/div

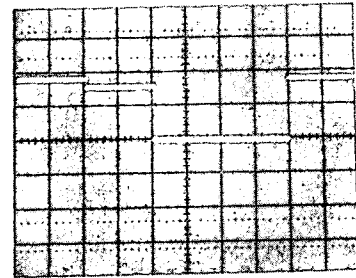

15 .2V/div  
.2msec/div

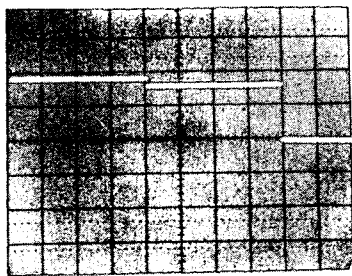

16 .2V/div  
.2msec/div

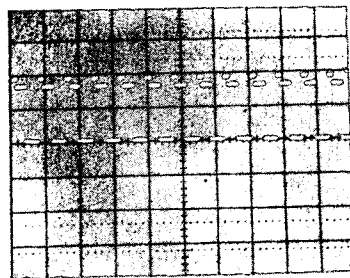

17 .2V/div  
1msec/div

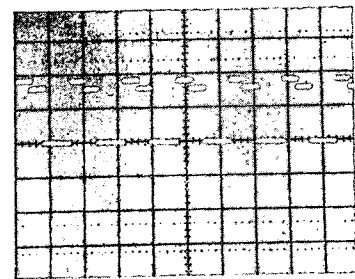

18 .2V/div  
.1μsec/div

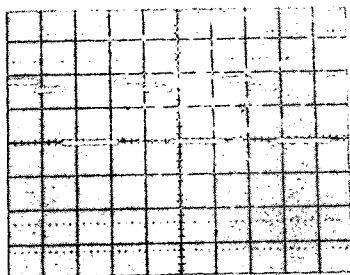

19 .2V/div  
.1μsec/div

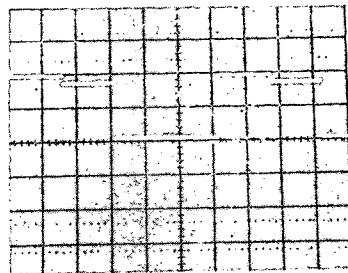

20 .2V/div  
.1μsec/div

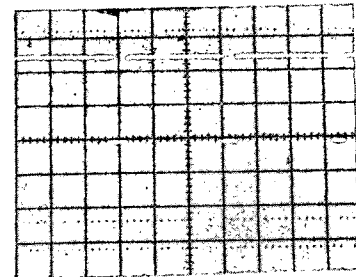

21 .2V/div  
1msec/div

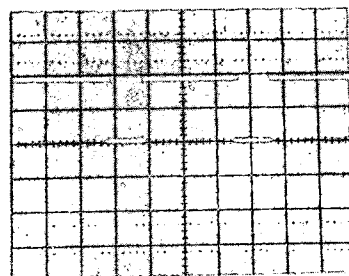

22 .2V/div  
50μsec/div

Figure 8-5. 5300B Waveforms Photographs (Continued)



Models 5300B and 5310A  
Schematic Diagrams

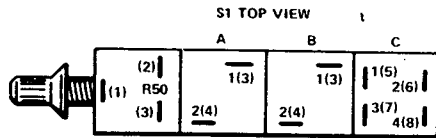

PIN NUMBERED IN PARENTHESIS ( )  
ARE LOCATED ON REVERSE SIDE  
OF SWITCHES

A1

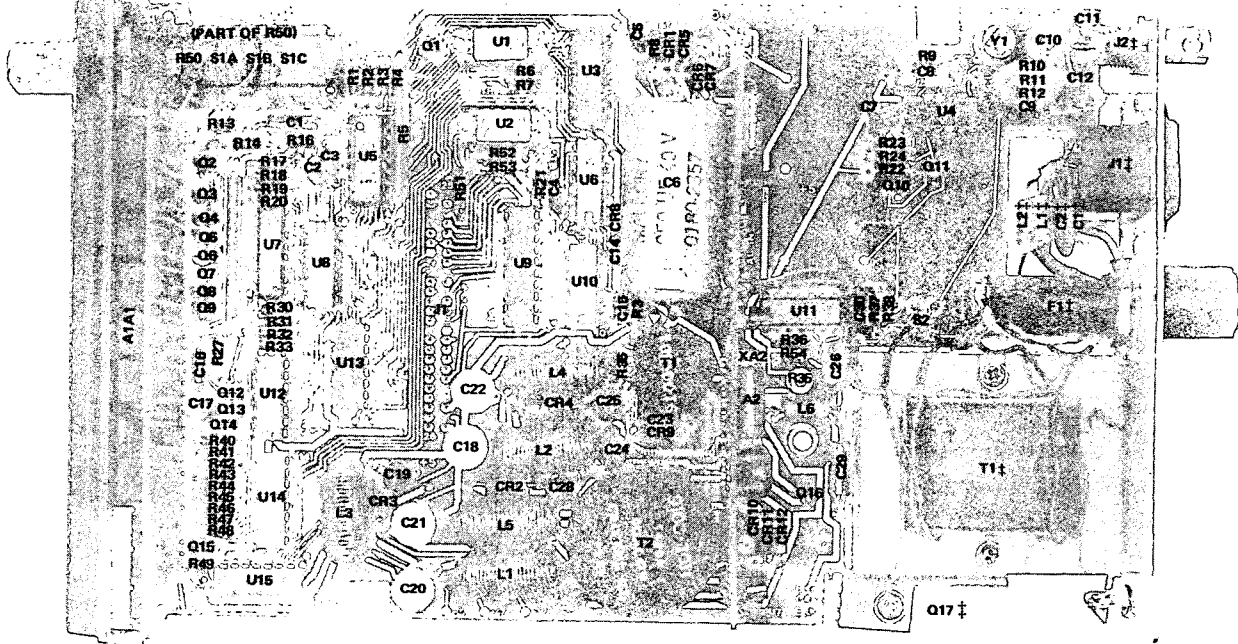

‡ CHASSIS MOUNTED PARTS - NOT PART OF A1

A2

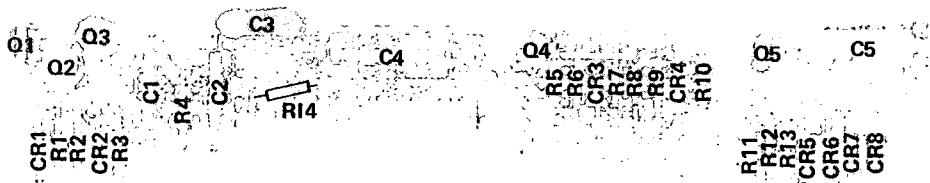

A1A1

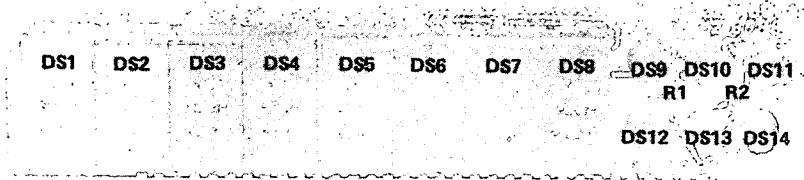
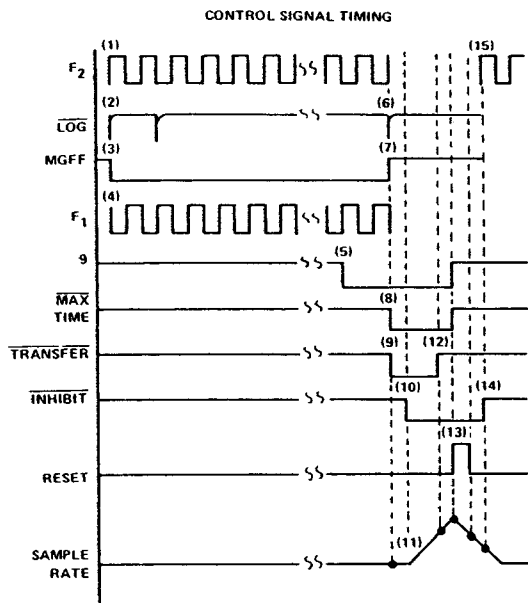

Figure 8-6. 5300B Parts Locations with Standard Time Base



A2 POWER SUPPLY REGULATOR ASSEMBLY (05300)

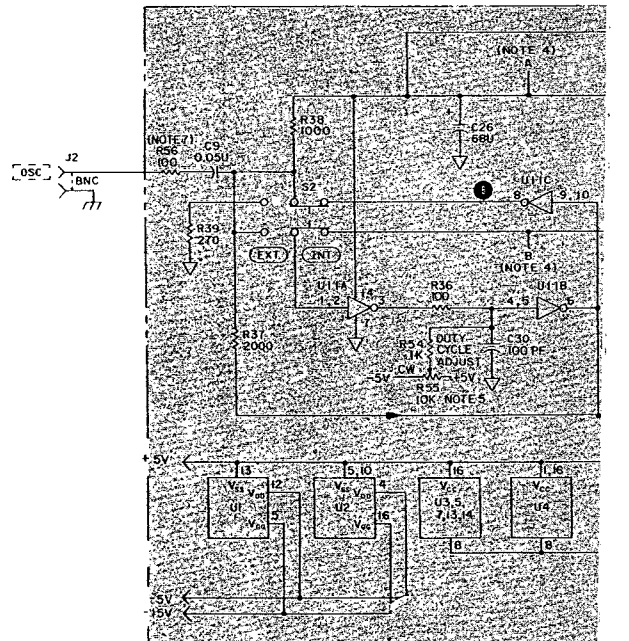
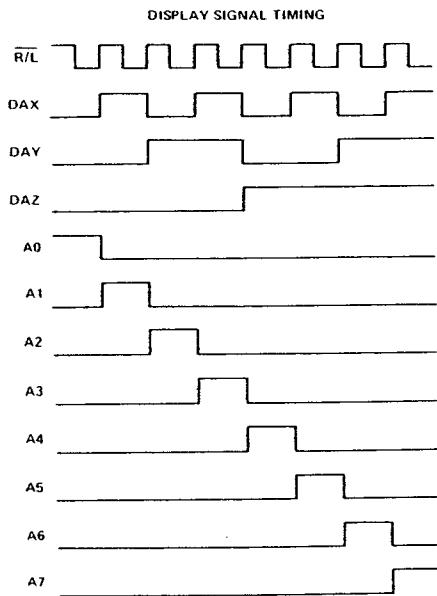
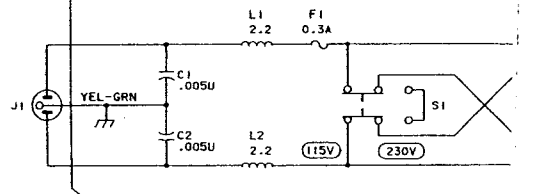
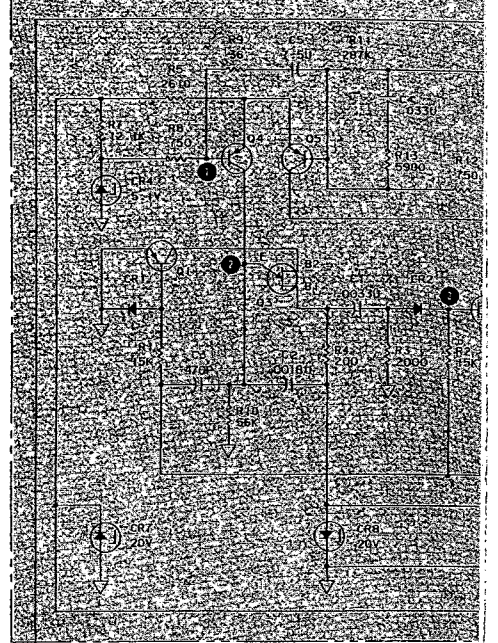
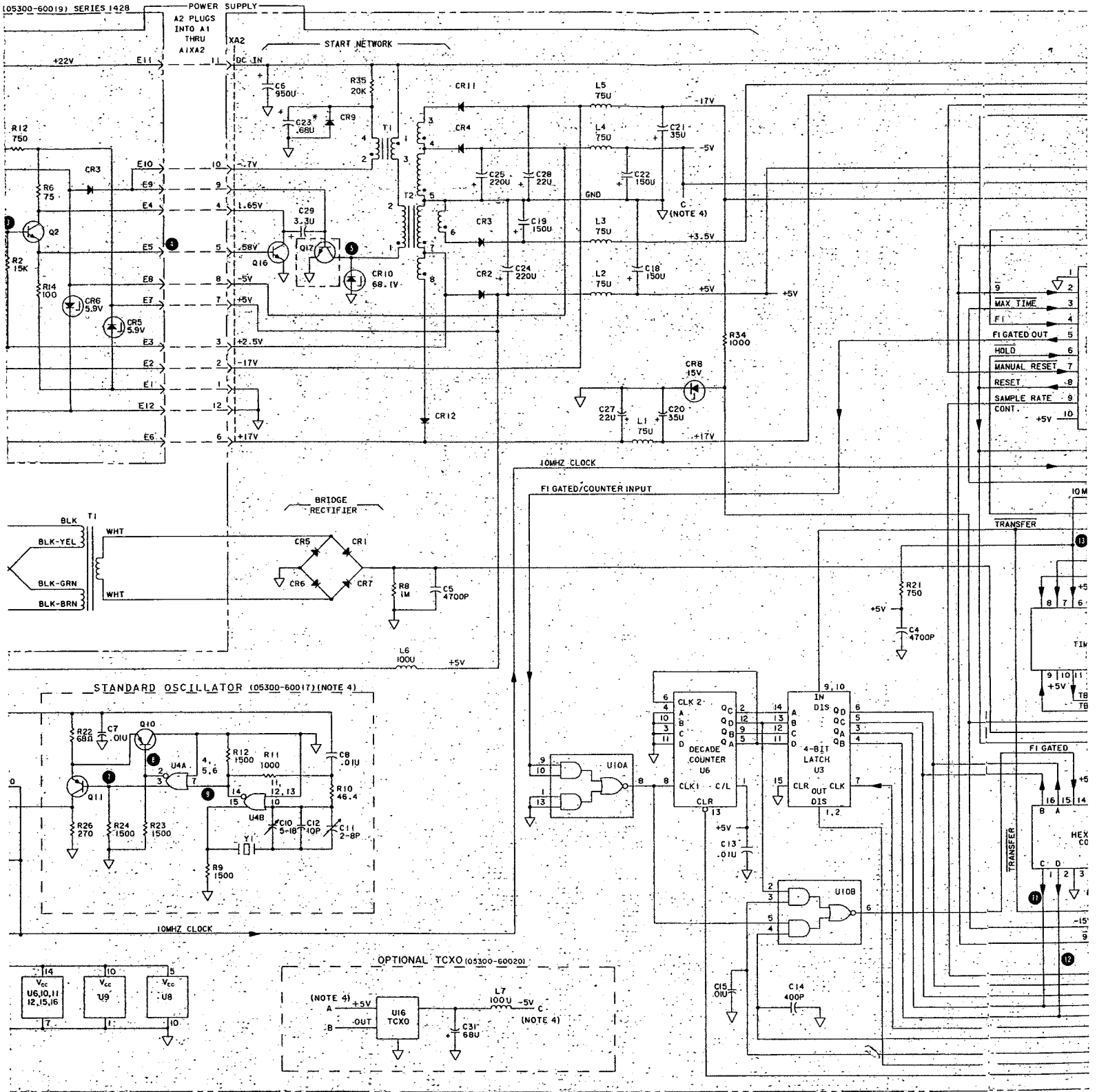
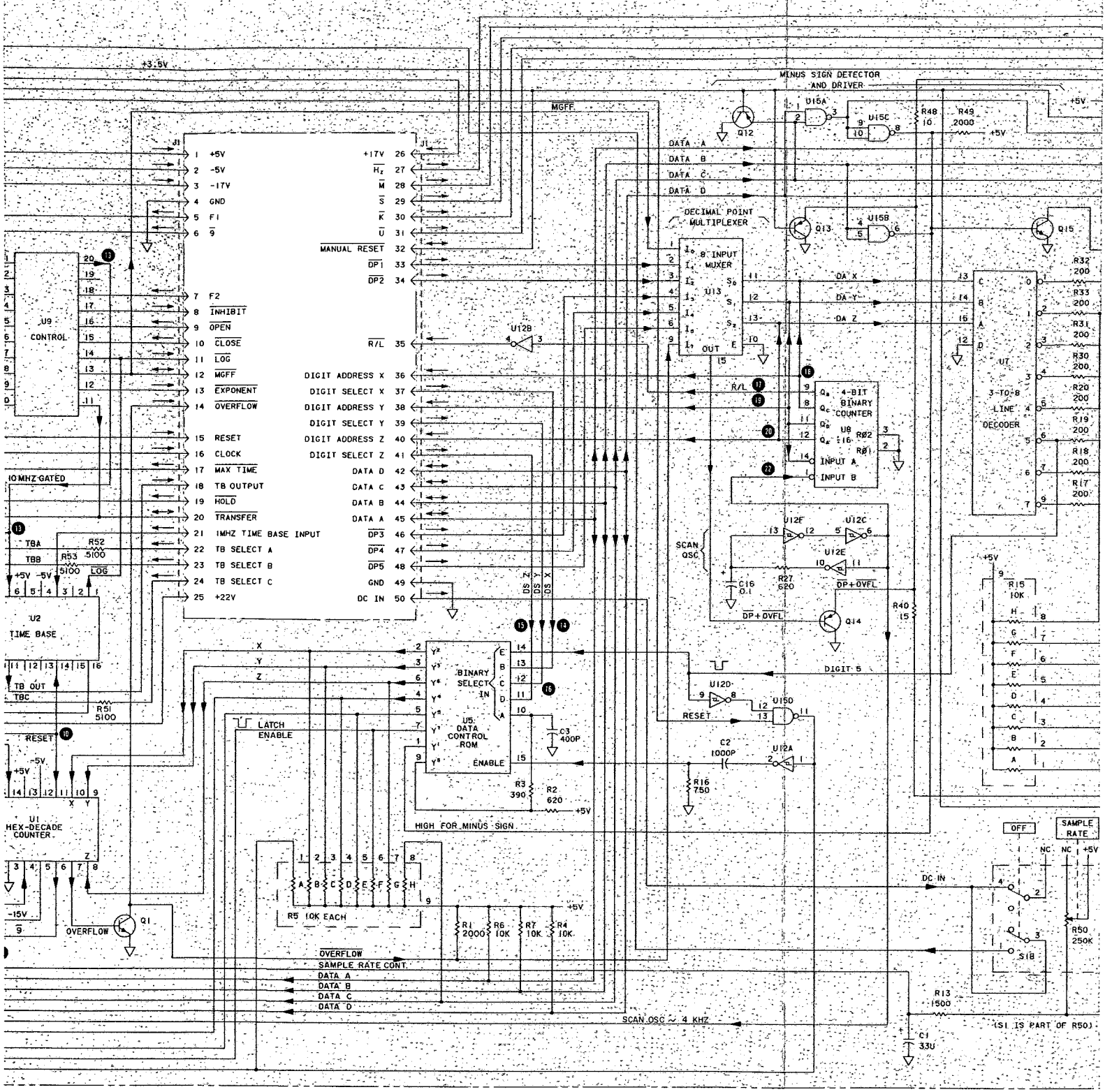
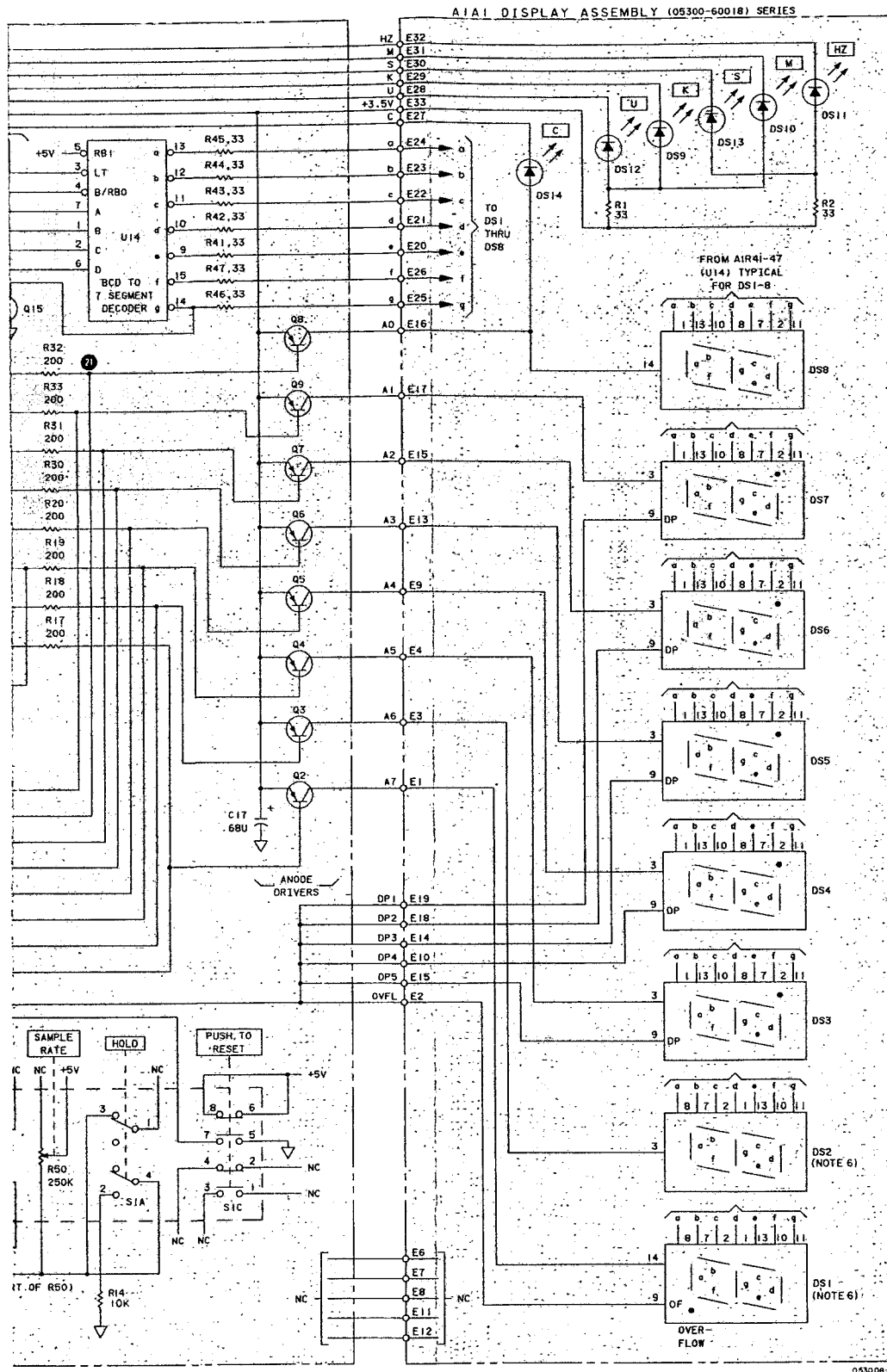

Figure 8-7. Control and Display Signals Timing Diagram

Manual Change Page  
Revision No. 2  
Revised: Oct. 1, 1976







NOTES

1. REFERENCE DESIGNATIONS WITHIN THIS ASSEMBLY ARE ABBREVIATED. ADD ASSEMBLY NUMBER TO ABBREVIATION FOR COMPLETE DESCRIPTION.
2. UNLESS OTHERWISE INDICATED: RESISTANCE VALUES ARE IN OHMS - CAPACITANCE VALUES ARE IN FARADS - INDUCTANCE VALUES ARE IN HENRIES.
3. ASTERISK (\*) INDICATES SELECTED COMPONENT, AVERAGE VALUES SHOWN.
4. ON 05300-60020 ASSEMBLY (OPT 001) TCXO REPLACES THE STANDARD OSCILLATOR CIRCUIT. A, B AND C INDICATE THE REPLACEMENT CONNECTION POINTS.
5. AIR55 IS ADJUSTED FOR SQUARE WAVE. CONNECT OSCILLOSCOPE TO J2 (OSC) FOR ADJUSTMENT.
6. A1A1DS1 AND A1A1DS2 ARE PHYSICALLY MOUNTED UPSIDE DOWN WITH RESPECT TO A1A1DS3 THRU A1A1DS8.

ACTIVE ELEMENTS TABLE					
A1		A1A1		A2	
REFERENCE DESIGNATIONS	HP PART NUMBER	REFERENCE DESIGNATIONS	HP PART NUMBER	REFERENCE DESIGNATIONS	HP PART NUMBER
CR1,2,5,6,7	1901 0028	DS1*	1990 0469(C)	CR1,2	1901 0040
CR2	1901 1081			CR3	1901 0050
CR3	1902 2205			CR4	1902 0689
CR4	1901 0050			CR5,6	1902 2110
CR5	1901 0050			CR7,8	1902 0556
CR6	1901 0050	DS9,14	1990 0325	Q1	1853 0020
CR7	1901 0050			Q2	1854 0023
CR8	1901 0050			Q3	1855 0367
CR9	1901 0050			Q4,5	1855 0086
CR10	1902 3381				
Q1,15	1854 0215	CR1,2	1901 0040		
Q2,3,4,5	1853 0318	CR3	1901 0050		
Q6,7,8,9	1853 0015	CR4	1902 0689		
Q10,11	1854 0482	CR5,6	1902 2110		
Q12,13,14	1853 0036	CR7,8	1902 0556		
Q16	1854 0482	Q1	1853 0020		
Q17	1854 0482	Q2	1854 0023		
U1	1820 0634	Q3	1855 0367		
U2	1820 0633	Q4	1853 0086		
U3	1820 1166	Q5	1853 0086		
U4	1820 0806				
U5	1816 0417				
U6	1820 1251				
U7	1820 0214				
U8	1820 0099				
U9	1820 0632W				
U10	1820 1190				
U11	1820 0377				
U12	1820 0270				
U13	1820 1416				
U14	1820 0658				
U15	1820 1037				
	1820 0955				

\*These parts are matched for brightness by suffix letter C or D or E.

- NOTES (CONTD.)
7. SERIES 1636A INSTRUMENTS WITH OPTION 001 (05300-60020 CKT 8D) ARE THE SAME AS SERIES 1452A EXCEPT FOR THE ADDITION OF AIR56 BETWEEN A1C9 AND J2. ADDITION OF THIS RESISTOR IS RECOMMENDED WHEN ADDING OPTION 001 TO ANY 5300 MAINFRAME. STANDARD INSTRUMENTS LESS OPTION 001 (05300-60017 CKT 8D) ARE IDENTICAL FOR SERIES 1452A AND 1636A.

Figure 8-7. Control and Display Signals Timing Diagram  
Figure 8-8. 5300B Schematic Diagram